

**PHILIPPINE BIDDING DOCUMENTS**

**Procurement of  
INFRASTRUCTURE  
PROJECTS**

Government of the Republic of the Philippines

**Sixth Edition  
July 2020**

# Preface

These Philippine Bidding Documents (PBDs) for the procurement of Infrastructure Projects (hereinafter referred to also as the “Works”) through Competitive Bidding have been prepared by the Government of the Philippines for use by all branches, agencies, departments, bureaus, offices, or instrumentalities of the government, including government-owned and/or -controlled corporations, government financial institutions, state universities and colleges, local government units, and autonomous regional government. The procedures and practices presented in this document have been developed through broad experience, and are for mandatory use in projects that are financed in whole or in part by the Government of the Philippines or any foreign government/foreign or international financing institution in accordance with the provisions of the 2016 revised Implementing Rules and Regulations (IRR) of Republic Act (RA) No. 9184.

The PBDs are intended as a model for admeasurements (unit prices or unit rates in a bill of quantities) types of contract, which are the most common in Works contracting.

The Bidding Documents shall clearly and adequately define, among others: (i) the objectives, scope, and expected outputs and/or results of the proposed contract; (ii) the eligibility requirements of Bidders; (iii) the expected contract duration; and (iv) the obligations, duties, and/or functions of the winning Bidder.

Care should be taken to check the relevance of the provisions of the PBDs against the requirements of the specific Works to be procured. If duplication of a subject is inevitable in other sections of the document prepared by the Procuring Entity, care must be exercised to avoid contradictions between clauses dealing with the same matter.

Moreover, each section is prepared with notes intended only as information for the Procuring Entity or the person drafting the Bidding Documents. They shall not be included in the final documents. The following general directions should be observed when using the documents:

- a. All the documents listed in the Table of Contents are normally required for the procurement of Infrastructure Projects. However, they should be adapted as necessary to the circumstances of the particular Project.
- b. Specific details, such as the “*name of the Procuring Entity*” and “*address for bid submission*,” should be furnished in the Instructions to Bidders, Bid Data Sheet, and Special Conditions of Contract. The final documents should contain neither blank spaces nor options.
- c. This Preface and the footnotes or notes in italics included in the Invitation to Bid, BDS, General Conditions of Contract, Special Conditions of Contract, Specifications, Drawings, and Bill of Quantities are not part of the text of the final document, although they contain instructions that the Procuring Entity should strictly follow.
- d. The cover should be modified as required to identify the Bidding Documents as to the names of the Project, Contract, and Procuring Entity, in addition to date of issue.

- e. Modifications for specific Procurement Project details should be provided in the Special Conditions of Contract as amendments to the Conditions of Contract. For easy completion, whenever reference has to be made to specific clauses in the Bid Data Sheet or Special Conditions of Contract, these terms shall be printed in bold typeface on Sections I (Instructions to Bidders) and III (General Conditions of Contract), respectively.
- f. For guidelines on the use of Bidding Forms and the procurement of Foreign-Assisted Projects, these will be covered by a separate issuance of the Government Procurement Policy Board.

# TABLE OF CONTENTS

<b>Glossary of Terms, Abbreviations, and Acronyms .....</b>	<b>5</b>
<b>Section I. Invitation to Bid.....</b>	<b>8</b>
<b>Section II. Instructions to Bidders .....</b>	<b>21</b>
1. Scope of Bid.....	22
2. Funding Information .....	22
3. Bidding Requirements.....	22
4. Corrupt, Fraudulent, Collusive, Coercive, and Obstructive Practices .....	23
5. Eligible Bidders.....	23
6. Origin of Associated Goods .....	23
7. Subcontracts .....	23
8. Pre-Bid Conference.....	23
9. Clarification and Amendment of Bidding Documents.....	24
10. Documents Comprising the Bid: Eligibility and Technical Components .....	24
11. Documents Comprising the Bid: Financial Component .....	24
12. Alternative Bids .....	25
13. Bid Prices .....	25
14. Bid and Payment Currencies.....	25
15. Bid Security.....	25
16. Sealing and Marking of Bids.....	26
17. Deadline for Submission of Bids .....	26
18. Opening and Preliminary Examination of Bids .....	26
19. Detailed Evaluation and Comparison of Bids.....	26
20. Post Qualification.....	27
21. Signing of the Contract .....	27
<b>Section III. Bid Data Sheet .....</b>	<b>28</b>
<b>Section IV. General Conditions of Contract.....</b>	<b>33</b>
1. Scope of Contract.....	34
2. Sectional Completion of Works .....	34
3. Possession of Site .....	34
4. The Contractor’s Obligations.....	34
5. Performance Security .....	35
6. Site Investigation Reports .....	35

7.	Warranty.....	35
8.	Liability of the Contractor.....	35
9.	Termination for Other Causes.....	35
10.	Dayworks .....	36
11.	Program of Work.....	36
12.	Instructions, Inspections and Audits .....	36
13.	Advance Payment.....	36
14.	Progress Payments .....	36
15.	Operating and Maintenance Manuals.....	36
<b>Section V. Special Conditions of Contract.....</b>		<b>38</b>
<b>Section VI. Specifications .....</b>		<b>41</b>
<b>Section VII. Drawings.....</b>		<b>51</b>
<b>Section VIII. Bill of Quantities .....</b>		<b>56</b>
<b>Section IX. Checklist of Technical and Financial Documents .....</b>		<b>59</b>

# *Glossary of Terms, Abbreviations, and Acronyms*

**ABC** – Approved Budget for the Contract.

**ARCC** – Allowable Range of Contract Cost.

**BAC** – Bids and Awards Committee.

**Bid** – A signed offer or proposal to undertake a contract submitted by a bidder in response to and in consonance with the requirements of the bidding documents. Also referred to as *Proposal* and *Tender*. (2016 revised IRR, Section 5[c])

**Bidder** – Refers to a contractor, manufacturer, supplier, distributor and/or consultant who submits a bid in response to the requirements of the Bidding Documents. (2016 revised IRR, Section 5[d])

**Bidding Documents** – The documents issued by the Procuring Entity as the bases for bids, furnishing all information necessary for a prospective bidder to prepare a bid for the Goods, Infrastructure Projects, and/or Consulting Services required by the Procuring Entity. (2016 revised IRR, Section 5[e])

**BIR** – Bureau of Internal Revenue.

**BSP** – Bangko Sentral ng Pilipinas.

**CDA** – Cooperative Development Authority.

**Consulting Services** – Refer to services for Infrastructure Projects and other types of projects or activities of the GOP requiring adequate external technical and professional expertise that are beyond the capability and/or capacity of the GOP to undertake such as, but not limited to: (i) advisory and review services; (ii) pre-investment or feasibility studies; (iii) design; (iv) construction supervision; (v) management and related services; and (vi) other technical services or special studies. (2016 revised IRR, Section 5[i])

**Contract** – Refers to the agreement entered into between the Procuring Entity and the Supplier or Manufacturer or Distributor or Service Provider for procurement of Goods and Services; Contractor for Procurement of Infrastructure Projects; or Consultant or Consulting Firm for Procurement of Consulting Services; as the case may be, as recorded in the Contract Form signed by the parties, including all attachments and appendices thereto and all documents incorporated by reference therein.

**Contractor** – is a natural or juridical entity whose proposal was accepted by the Procuring Entity and to whom the Contract to execute the Work was awarded. Contractor as used in these Bidding Documents may likewise refer to a supplier, distributor, manufacturer, or consultant.

**CPI** – Consumer Price Index.

**DOLE** – Department of Labor and Employment.

**DTI** – Department of Trade and Industry.

**Foreign-funded Procurement or Foreign-Assisted Project** – Refers to procurement whose funding source is from a foreign government, foreign or international financing institution as specified in the Treaty or International or Executive Agreement. (2016 revised IRR, Section 5[b]).

**GFI** – Government Financial Institution.

**GOCC** – Government-owned and/or –controlled corporation.

**Goods** – Refer to all items, supplies, materials and general support services, except Consulting Services and Infrastructure Projects, which may be needed in the transaction of public businesses or in the pursuit of any government undertaking, project or activity, whether in the nature of equipment, furniture, stationery, materials for construction, or personal property of any kind, including non-personal or contractual services such as the repair and maintenance of equipment and furniture, as well as trucking, hauling, janitorial, security, and related or analogous services, as well as procurement of materials and supplies provided by the Procuring Entity for such services. The term “related” or “analogous services” shall include, but is not limited to, lease or purchase of office space, media advertisements, health maintenance services, and other services essential to the operation of the Procuring Entity. (2016 revised IRR, Section 5[r])

**GOP** – Government of the Philippines.

**Infrastructure Projects** – Include the construction, improvement, rehabilitation, demolition, repair, restoration or maintenance of roads and bridges, railways, airports, seaports, communication facilities, civil works components of information technology projects, irrigation, flood control and drainage, water supply, sanitation, sewerage and solid waste management systems, shore protection, energy/power and electrification facilities, national buildings, school buildings, hospital buildings, and other related construction projects of the government. Also referred to as *civil works or works*. (2016 revised IRR, Section 5[u])

**LGUs** – Local Government Units.

**NFCC** – Net Financial Contracting Capacity.

**NGA** – National Government Agency.

**PCAB** – Philippine Contractors Accreditation Board.

**PhilGEPS** - Philippine Government Electronic Procurement System.

**Procurement Project** – refers to a specific or identified procurement covering goods, infrastructure project or consulting services. A Procurement Project shall be described, detailed, and scheduled in the Project Procurement Management Plan prepared by the agency which shall be consolidated in the procuring entity's Annual Procurement Plan. (GPPB Circular No. 06-2019 dated 17 July 2019)

**PSA** – Philippine Statistics Authority.

**SEC** – Securities and Exchange Commission.

**SLCC** – Single Largest Completed Contract.

**UN** – United Nations.



## ***Section I. Invitation to Bid***

### **Notes on the Invitation to Bid**

The Invitation to Bid (IB) provides information that enables potential Bidders to decide whether to participate in the procurement at hand. The IB shall be posted in accordance with Section 21.2 of the 2016 revised IRR of RA No. 9184.

Apart from the essential items listed in the Bidding Documents, the IB should also indicate the following:

- a. The date of availability of the Bidding Documents, which shall be from the time the IB is first advertised/posted until the deadline for the submission and receipt of bids;
- b. The place where the Bidding Documents may be acquired or the website where it may be downloaded;
- c. The deadline for the submission and receipt of bids; and
- d. Any important bid evaluation criteria.

The IB should be incorporated into the Bidding Documents. The information contained in the IB must conform to the Bidding Documents and in particular to the relevant information in the Bid Data Sheet.

**REPUBLIC OF THE PHILIPPINES**  
**DEPARTMENT OF SOCIAL WELFARE AND DEVELOPMENT**

DSWD Field Office III, Diosdado Macapagal Government Center, Maimpis,  
City of San Fernando Pampanga, Philippines 2000  
Tel: (045) 861 – 2413 ; Telefax: (045) 961 – 2413  
Email: bac.fo3@dswd.gov.ph website: <https://fo3.dswd.gov.ph>

**INVITATION TO BID**

**SUPPLY, INSTALLATION AND TESTING OF ADDRESSABLE FIRE DETECTION AND ALARM SYSTEM (FDAS) OF AMOR VILLAGE, SAN FRANCISCO EAST ANAO, TARLAC CITY**

ITB No. GOP/DSWD3-2024-04-0003  
(PR No. 2024-01-46)

The Department of Social Welfare and Development (DSWD) - Field Office III, through the GAA FY 2024 – intends to apply herein below Approved Budget of the Contract to payments under the contract for “**SUPPLY, INSTALLATION AND TESTING OF ADDRESSABLE FIRE DETECTION AND ALARM SYSTEM (FDAS) OF AMOR VILLAGE, SAN FRANCISCO EAST ANAO, TARLAC CITY**”. Bids received in excess of the ABC shall be automatically rejected at bid opening.

<b>LOT</b>	<b>PARTICULAR</b>	<b>ABC (In Phil Peso)</b>	<b>Cost of Bidding Document</b>
	SUPPLY, INSTALLATION AND TESTING OF ADDRESSABLE FIRE DETECTION AND ALARM SYSTEM (FDAS) OF AMOR VILLAGE, SAN FRANCISCO EAST ANAO, TARLAC CITY	Php 1,282,421.41	Php 5,000.00

1. The **Department of Social Welfare and Development (DSWD) - Field Office III** now invites bids for the above Procurement Project. Completion of the Works

should be within Thirty-Five (35) Calendar Days. Bidder must have **at least ten (10) years** from the date of submission and receipt of bids, a contract similar to the Project. The description of an eligible bidder is contained in the Bidding Documents, particularly, in Section II (Instructions to Bidders).

2. Bidding will be conducted through open competitive bidding procedures using non-discretionary “*pass/fail*” criterion as specified in the 2016 revised Implementing Rules and Regulations (IRR) of Republic Act (RA) No. 9184.
3. Prospective Bidders may obtain further information from Department of Social Welfare and Development Field Office III and inspect the Bidding Documents at the address given below or at the DSWD Field Office III official website.

In compliance with GPPB Resolution 09-2020 entitled, “Approving Measures for the Efficient Conduct of Procurement Activities during a State of Calamity or Implementation of Community Quarantine or Similar Restrictions”, the DSWD Bids and Awards Committee has confirmed, adopted, and approved measures for online or electronic bidding, as recommended by the GPPB-TSO, for the efficient conduct of all procurement activities, regardless of the procurement modality, during the pandemic in preparation for the full implementation of GPPB Resolution No. 21-2021 using E- Bidding Facility of the Modernized Philippine Government Electronic Procurement System (mPhilGEPS).

In view of this, the procedure for this procurement project shall be in accordance with DSWD BAC Resolution No. 2021-10-01 relative to the Implementation of Electronic Submission and Receipt of Bids and the Bidder’s Kit on Guidelines to Bidders in Adopting Electronic Submission of Bids is attached herewith as Annex “A.”

4. Interested bidders may obtain further information from **Bids and Awards Committee (BAC) Secretariat** of the Procuring Entity and inspect the Bidding Documents posted at DSWD Field Office III.
5. A complete set of Bidding Documents may be acquired by interested Bidders on **April 25, 2024 to May 7, 2024 (12:00 NN)** from the given address and website(s) below and upon payment of the applicable fee for the Bidding Documents, pursuant to the latest Guidelines issued by the GPPB. The Procuring Entity shall allow the bidder to present its proof of payment for the fees in person or electronic mail.

Interested Bidders shall contact the BAC Secretariat through e-mail at [quotation.fo3@dswd.gov.ph](mailto:quotation.fo3@dswd.gov.ph) for further instructions on the purchase and payment of the Bidding Documents.

Upon receipt from the BAC of an official Acknowledgement Receipt of Bid and payment of the Bidding Document Fee, the bidder shall submit to the BAC Secretariat clear digital copies of the aforementioned Acknowledgement Receipt of Bid and either clear scanned copy of Official Receipt issued by the DSWD Field Office III Cashier’s Office on or before the deadline of submission of bids.

6. Department of Social Welfare and Development Field Office III will hold a **Pre-Bid Conference on April 25, 2024 | 1:30 PM through video conferencing or webcasting via Google Meet** which shall be open to prospective bidders.

A pre-registration shall be required for all interested suppliers in order to access the video conferences and to participate further in the procurement activities as scheduled. Those interested bidders must provide complete information in the Google Forms which may be accessed via this link: <https://tinyurl.com/DSWDe-bid>.

Prospective bidders are encouraged to discuss any concerns or clarifications about the eligibility requirements including the technical specifications in the said conference.

7. Bids must be duly received and acknowledged by the BAC Secretariat through online or electronic submission **on or before May 7, 2024** at 12:00NN in the manner compliant with the submission of eligibility documents for public bidding and in accordance with the above-mentioned DSWD BAC Resolution No. 2021-10-01 relative to the Implementation of Electronic Submission and Receipt of Bids and the Bidder's Kit on Guidelines to Bidders in Adopting Electronic Submission of Bids.
8. All bids must be accompanied by a bid security in any of the acceptable forms and in the amount stated in **ITB** Clause 16.
9. Bid opening shall be **on May 7, 2024** at 1:30PM via Google Meet video conferencing. Bids will be opened in the presence of the bidders' representatives who choose to attend the activity.
10. Prospective bidders are requested to organize and submit their Bids electronically as provided under the Bidder's Kit on **Guidelines to Bidders in Adopting Electronic Submission of Bids**. and suppliers are hereby reminded, as follows:
  - a) The submission of the Legal and Technical Documents (First Envelope) and Financial Documents (Second Envelope) shall be in PDF file;
  - b) Scan the original copy of the **Legal and Technical Requirements** and save as PDF, after scanning the original copy of the **Legal and Technical Requirements**, place the scanned files in one folder with file name "**Legal and Technical Documents**" and compress the folder using **WinRAR Extractor Application** with file name "**Folder 1 - Legal and Technical Documents**", assign a strong password on the compressed file;
  - c) Scan the original copy of the **Financial Requirements** and save as PDF, after scanning the original copy of the **Financial Requirements**, place the scanned files in one folder with file name "**Financial Requirements**" and compress the folder using **WinRAR Extractor Application** with file name "**Folder 2 - Financial Documents**", assign a password on the compressed file;

d) After encrypting the **Legal and Technical, and Financial Requirements**, encrypt the two (2) encrypted files using **WinRAR Extractor Application** with file name **“DSWD-FOIII ITB No. \_\_\_ - (Name of Bidder)”**, and assign a strong password;

In case of modification of bids by the bidder, the bidder shall use the file name for the main file **“DSWD-FOIII ITB No. - (Name of Bidder) - Final”**

The original bid submitted shall not be retrieved but a modified bid shall be submitted to the BAC Secretariat official uploading site provided that it is equally secured by strong password, properly identified, and submitted on or before the set deadline.

**Important:** Passwords shall bear a unique combination for each file. Same passwords for any and all files are strictly not allowed. Please see attached **ANNEX** for your guidance.

e) Submit/Upload your bids thru this link: <https://tinyurl.com/dswfo3cbupload> on or before the set deadline;

f) After submission of your bids, wait for an acknowledgement of BAC via email for the confirmation of your submitted bids indicating the Date and Time of your submission; and

g) Also, the link for the Opening of Bids will be sent to your registered email upon submission of the copy of the Acknowledgement Receipt of Bid and proof of payment of the bidding document to the BAC Secretariat as stated in item no.6 hereof.

**Important:** All bids submitted after the deadline will NOT be considered in the bid opening.

It is the responsibility of the bidders who submitted their bids electronically to monitor receipt of an auto-generated bid receipt acknowledging their bid submission. Failure to receive a bid receipt means the submission was not successful.

In case the bidder fails to submit any or all of the folders containing the documentary requirements in unique password-protected RAR files, the bid/quotation will automatically be disqualified and shall be declared as **“FAILED”** and the supplier will no longer be allowed to participate further in the procurement activities scheduled for this project.

11. After the opening and evaluation of bids, the BAC, its staff and personnel, Secretariat and Technical Working Group (TWG), as well as Observers are prohibited from making or accepting any communication with any bidder regarding the evaluation of their bids until issuance of Notice of Award (NOA). However, the BAC, through its Secretariat, may ask in writing the bidder for

clarification of its request in writing. All responses to requests for clarification shall be in writing.

12. The DSWD FO III reserves the right to reject any and all bids, declare a failure of bidding, or not award the contract at any time prior to contract award in accordance with Sections 35.6 and 41 of the 2016 revised IRR of RA No. 9184, without thereby incurring any liability to the affected bidder or bidders.
13. For further information, please refer to:

**THE CHAIRPERSON**

Bids and Awards Committee c/o BAC Secretariat  
DSWD Field Office III, Diosdado Macapagal Government Center,  
Maimpis, City of San Fernando, Pampanga, Philippines  
Tel: (045) 961 – 2143

You may visit the following websites:

For downloading of Bidding Documents:

**ps-philgeps.gov.ph** - Website of the Philippine Government Electronic Procurement System (PhilGEPS)

**www.fo3.dswd.gov.ph** – Website of the DSWD Field Office III

**https://tinyurl.com/fo3bacsite**– Website of the DSWD Field Office III BAC

Prospective bidders are **required** to pay for the purchase of the project's Philippine Bidding Documents **personally at DSWD FO III.**

*Sgd.*

**MARIBEL M. BLANCO**  
Bids and Awards Committee Chairperson

**(ANNEX)**  
**DEPARTMENT OF SOCIAL WELFARE AND DEVELOPMENTFIELD**  
**OFFICE IIBIDS AND AWARDS COMMITTEE**

**GUIDELINES TO BIDDERS IN ADOPTING ELECTRONIC  
SUBMISSION OF BIDS**

(GPPB Resolution No. 09-2020)

*For Pre-Bidding Conference*

**Step 1:** Register by completing the information required in the Google Forms that can be accessed with this link: <https://tinyurl.com/DSWDe-bid>. Once the form is successfully submitted, wait for an acknowledgement that will be sent to you via email.

**Step 2:** Attend in the scheduled Pre-Bid Conference by clicking the link attached in the Acknowledgement email.

**Step 3:** Wait for the Bids and Awards Committee to accept your entry in the set conference.

*For Submission of Bids*

**Step 1:** Scan the original copy of the Legal and Technical Requirements and save as PDF, after scanning the original copy of the Legal and Technical Requirements, place the scanned files in one folder with file name “Legal and Technical Documents” and compress the folder using WinRAR Extractor Application with file name “Folder 1 - Legal and Technical Documents”, assign a strong password on the compressed file.

**Step 2:** Scan the original copy of the Financial Requirements and save as PDF, after scanning the original copy of the Financial Requirements, place the scanned files in one folder with file name “Financial Requirements” and compress the folder using WinRAR Extractor Application with file name “Folder 2 - Financial Documents”, assign a strong password on the compressed file.

**Step 3:** After encrypting the Legal and Technical, and Financial Requirements, compress the two (2) encrypted files using WinRAR Extractor Application with file name “DSWD-FOIII Bidding No.\_\_\_\_- (Name of Bidder)”, and assign a strong password.

In case of modification of bids by the bidder, the bidder shall use the file name for the main file “DSWD-FOIII ITB No.\_\_\_\_ - (Name of Bidder) - Final”

The original bid submitted shall not be retrieved but a modified bid shall be submitted to the BAC Secretariat official uploading site provided that it is equally secured by password, properly identified, and submitted on or before the set deadline. The bidder shall use the following file names:

Important: Passwords shall bear a unique combination for each folder. Same passwords for all folders are strictly not allowed. Please see attached ANNEX for your guidance.

**Step 4:** Submit/Upload your bids thru this link: <https://tinyurl.com/dswfo3cbupload> on or before the set deadline.

**Step 5:** After submission of your bids, wait for an acknowledgement of BAC via email for the confirmation of your submitted bids indicating the Date and Time of your submission. Print the confirmation sent by the BAC as proof of your submission and send it to the BAC Secretariat together with your proof of payment to receive the link for the Opening of Bids.

**IMPORTANT:** All bids submitted after the deadline will NOT be considered in the bid opening.

### **For Opening of Bids**

**Step 1:** Open the email and access the link provided by the Secretariat to enter in the video conference. Wait for the confirmation from the BAC Secretariat to enter the meeting room.

*[Failure to compress the Main Folder using WinRAR Extractor Application and/or place a password thereto as well as failure to set unique passwords for the Legal & Technical Folder and/or Financial folder will warrant the AUTOMATIC DISQUALIFICATION of such bidder];*

**Step 2:** When prompted, disclose in the chatbox the password to the password-protected RAR folder. The BAC Secretariat will prompt you to disclose the password for the document containing the Legal and Technical Requirements. If you are present, the BAC Secretariat will ask in the chatbox of the Google Meet video conferencing room for the corresponding password during the bid opening itself.

**Step 3:** Should the Legal and Technical requirements be declared as "PASSED", you will be prompted to disclose the password for the PDF document containing the Financial Requirements. You must respond promptly.

**IMPORTANT NOTE:** If you are not present in the online meeting in Google Meet, the Secretariat will send you an inquiry for such password via text message to your registered mobile number. You are given a **maximum of five (5) minutes to respond.**



Should you not respond with the password when prompted, the BAC shall move on to the next bid, if any. If there are no other bids to be considered, the Secretariat shall ask again via text message for the password, and you are given another five (5) minutes to respond. Should you fail to respond within the allotted time, your submitted bid will no longer be considered.

The participating bidder shall only have **three (3) attempts** to provide the correct password for each folder.

### **Compressing your Files into password-protected RAR**

#### **formatFor Legal and Technical Requirements (based on the checklist)**

- Place the scanned files in one (1) folder with filename **“Legal and TechnicalRequirements”**

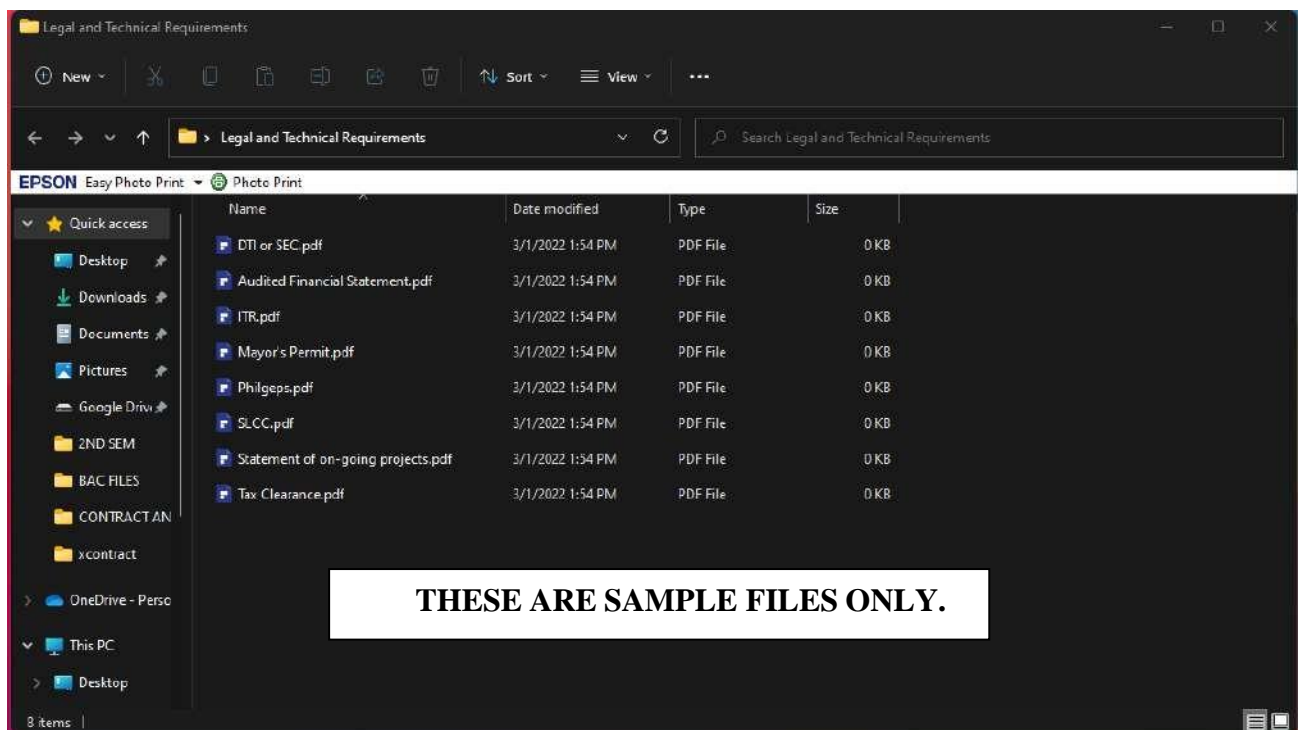

- Compress the folder using **WinRAR Extractor Application** with filename **“Folder 1**

**Legal and Technical Documents” and set a strong password**

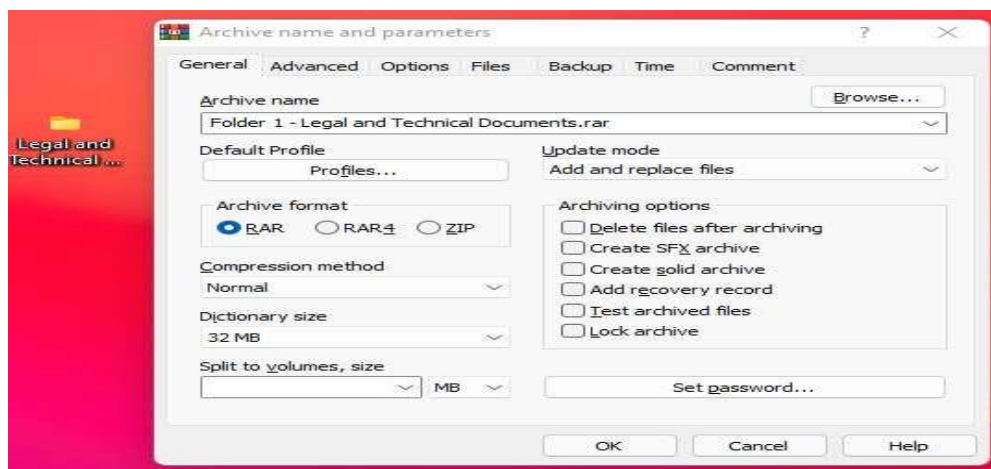

## For Financial Requirements (based on the checklist)

- Place the scanned files in one (1) folder with filename **“Financial Requirements”**

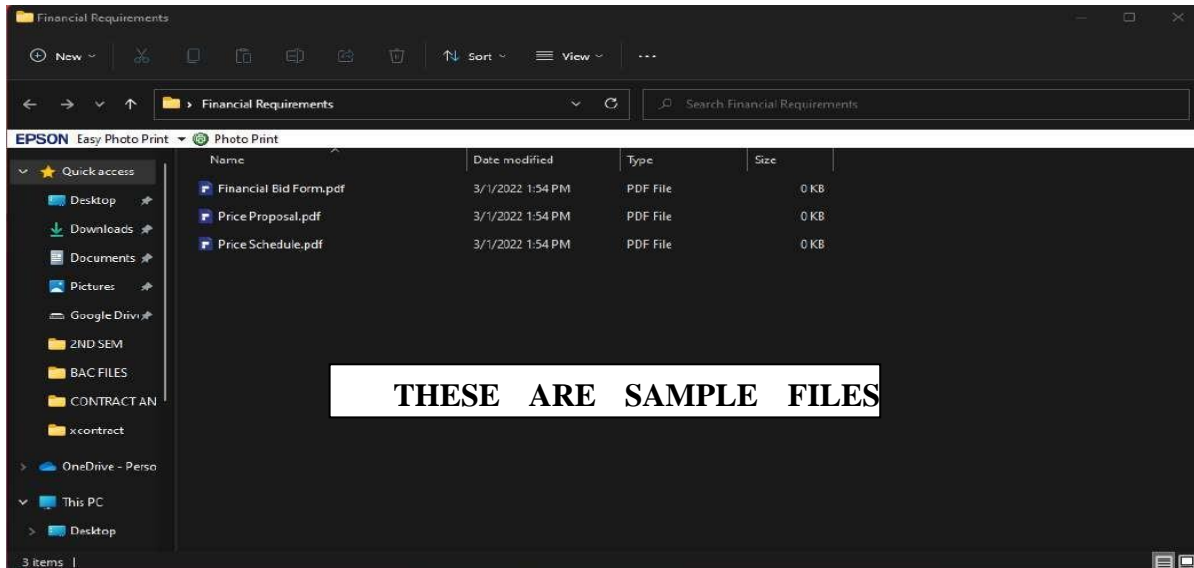

- Compress the folder using **WinRAR Extractor Application** with filename **“Folder 2 -**

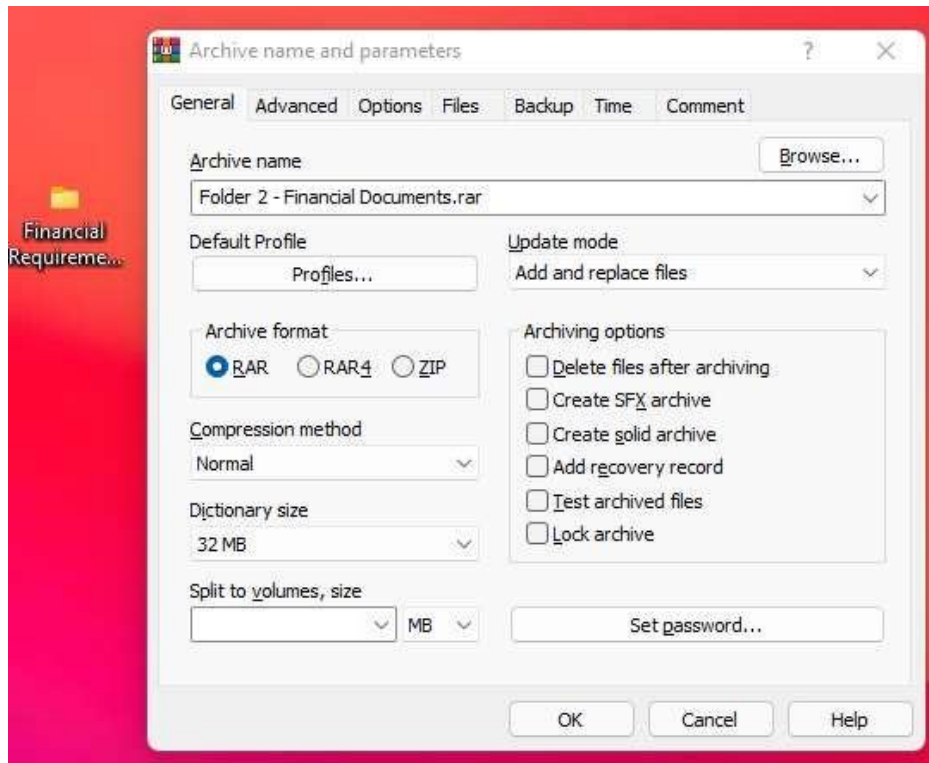

**Financial Documents” and set a strong password**

- After encrypting the **Legal and Technical, and Financial Requirements**, compress the two (2) password-protected RAR files using **WinRAR Extractor Application** with filename “**DSWD-FOIII ITB No. \_- (Name of Bidder)**”, and set a strong password

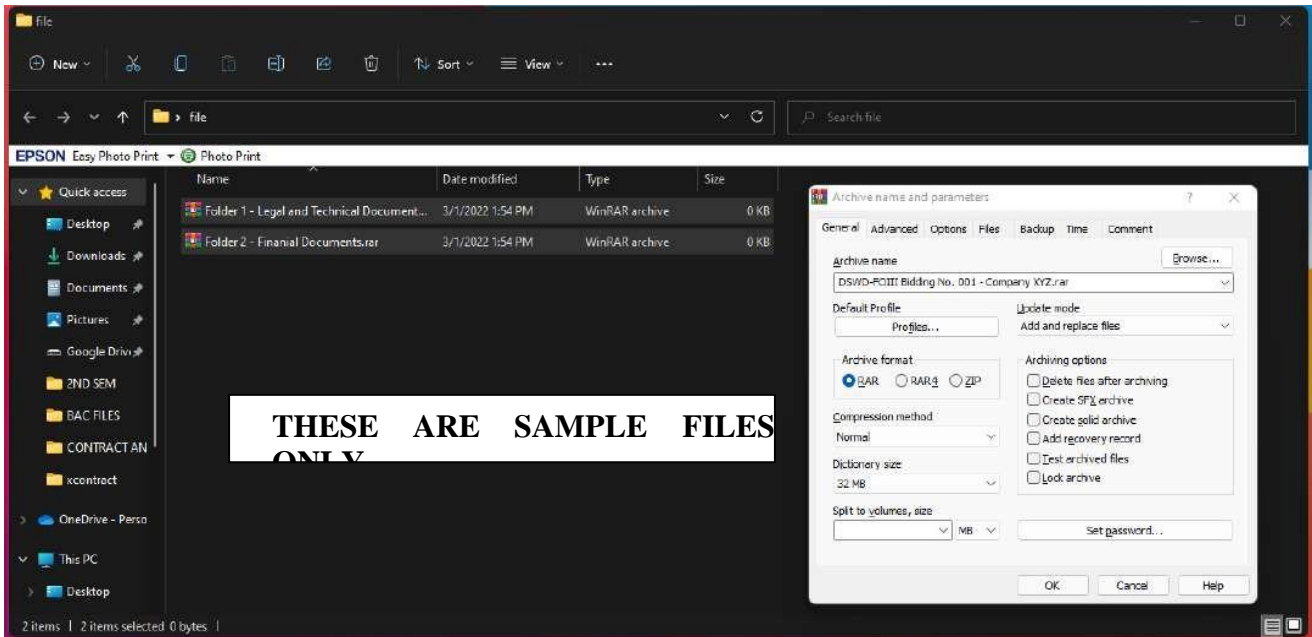

**Important:**

- Passwords shall bear a unique combination for each file. Same passwords for any and all files are **strictly not allowed**. Please see attached **ANNEX** for your guidance.

**In case of modification of bids by the bidder**, the bidder shall use the file name for the main file

“**DSWD-FOIII ITB No. \_\_\_\_\_ - (Name of Bidder) - Final**”

The original bid submitted shall not be retrieved but a modified bid shall be submitted to the BAC Secretariat official uploading site provided that it is equally secured by password, properly identified, and submitted on or before the set deadline.

## ***Section II. Instructions to Bidders***

### **Notes on the Instructions to Bidders**

This Section on the Instruction to Bidders (ITB) provides the information necessary for bidders to prepare responsive bids, in accordance with the requirements of the Procuring Entity. It also provides information on bid submission, eligibility check, opening and evaluation of bids, post-qualification, and on the award of contract.

## **1. Scope of Bid**

The Procuring Entity, DEPARTMENT OF SOCIAL WELFARE AND DEVELOPMENT FIELD OFFICE III wishes to receive Bids for the “SUPPLY, INSTALLATION AND TESTING OF ADDRESSABLE FIRE DETECTION AND ALARM SYSTEM (FDAS) OF AMOR VILLAGE, SAN FRANCISCO EAST ANAO, TARLAC CITY” with identification number ITB NO. GOP/DSWD3-2024-04-0003.

The Procurement Project referred to herein as Project: “SUPPLY, INSTALLATION AND TESTING OF ADDRESSABLE FIRE DETECTION AND ALARM SYSTEM (FDAS) OF AMOR VILLAGE, SAN FRANCISCO EAST ANAO, TARLAC CITY”, the details of which are described in Section VII (Technical Specifications).

## **2. Funding Information**

2.1. The GOP through the source of funding as indicated below for **GAA CONTINUING FUNDS CY 2024** in the amount of **ONE MILLION TWO HUNDRES EIGHTY-TWO THOUSAND FOUR HUNDRED TWENTY-ONE PESOS AND 41/100 (Php 1,282,421.41)**.

2.2. The source of funding is:

NGA, the General Appropriations Act or Special Appropriations

## **3. Bidding Requirements**

The Bidding for the Project shall be governed by all the provisions of RA No. 9184 and its 2016 revised IRR, including its Generic Procurement Manual and associated policies, rules and regulations as the primary source thereof, while the herein clauses shall serve as the secondary source thereof.

Any amendments made to the IRR and other GPPB issuances shall be applicable only to the ongoing posting, advertisement, or invitation to bid by the BAC through the issuance of a supplemental or bid bulletin.

The Bidder, by the act of submitting its Bid, shall be deemed to have inspected the site, determined the general characteristics of the contracted Works and the conditions for this Project, such as the location and the nature of the work; (b) climatic conditions; (c) transportation facilities; (c) nature and condition of the terrain, geological conditions at the site communication facilities, requirements, location and availability of construction aggregates and other materials, labor, water, electric power and access roads; and (d) other factors that may affect the cost, duration and execution or implementation of the contract, project, or work and examine all instructions, forms, terms, and project requirements in the Bidding Documents.

#### **4. Corrupt, Fraudulent, Collusive, Coercive, and Obstructive Practices**

The Procuring Entity, as well as the Bidders and Contractors, shall observe the highest standard of ethics during the procurement and execution of the contract. They or through an agent shall not engage in corrupt, fraudulent, collusive, coercive, and obstructive practices defined under Annex “I” of the 2016 revised IRR of RA No. 9184 or other integrity violations in competing for the Project.

#### **5. Eligible Bidders**

- 5.1. Only Bids of Bidders found to be legally, technically, and financially capable will be evaluated.
- 5.2. The Bidder must have an experience of having completed a Single Largest Completed Contract (SLCC) that is similar to this Project, equivalent to at least fifty percent (50%) of the ABC adjusted, if necessary, by the Bidder to current prices using the PSA’s CPI, except under conditions provided for in Section 23.4.2.4 of the 2016 revised IRR of RA No. 9184.

A contract is considered to be “similar” to the contract to be bid if it has the major categories of work stated in the **BDS**.

- 5.3. For Foreign-funded Procurement, the Procuring Entity and the foreign government/foreign or international financing institution may agree on another track record requirement, as specified in the Bidding Document prepared for this purpose.
- 5.4. The Bidders shall comply with the eligibility criteria under Section 23.4.2 of the 2016 IRR of RA No. 9184.

#### **6. Origin of Associated Goods**

There is no restriction on the origin of Goods other than those prohibited by a decision of the UN Security Council taken under Chapter VII of the Charter of the UN.

#### **7. Subcontracts**

- 7.1. The Bidder may subcontract portions of the Project to the extent allowed by the Procuring Entity as stated herein, but in no case more than fifty percent (50%) of the Project.

The Procuring Entity has prescribed that:

**SUBCONTRACTING IS NOT ALLOWED.**

#### **8. Pre-Bid Conference**



The Procuring Entity will hold a pre-bid conference for this Project on the specified date and time and through videoconferencing Google Meet as indicated in paragraph 6 of the IB.

## **9. Clarification and Amendment of Bidding Documents**

Prospective bidders may request for clarification on and/or interpretation of any part of the Bidding Documents. Such requests must be in writing and received by the Procuring Entity, either at its given address or through electronic mail indicated in the **IB**, at least ten (10) calendar days before the deadline set for the submission and receipt of Bids.

## **10. Documents Comprising the Bid: Eligibility and Technical Components**

10.1. The first envelope shall contain the eligibility and technical documents of the Bid as specified in **Section IX. Checklist of Technical and Financial Documents**.

*(Reference must be made to herewith attached Guidelines to Bidders in Adopting Electronic Submission of Bids)*

10.2. If the eligibility requirements or statements, the bids, and all other documents for submission to the BAC are in foreign language other than English, it must be accompanied by a translation in English, which shall be authenticated by the appropriate Philippine foreign service establishment, post, or the equivalent office having jurisdiction over the foreign bidder's affairs in the Philippines. For Contracting Parties to the Apostille Convention, only the translated documents shall be authenticated through an apostille pursuant to GPPB Resolution No. 13-2019 dated 23 May 2019. The English translation shall govern, for purposes of interpretation of the bid.

10.3. A valid special PCAB License in case of Joint Ventures, and registration for the type and cost of the contract for this Project. Any additional type of Contractor license or permit shall be indicated in the **BDS**.

10.4. A List of Contractor's key personnel (e.g., Project Manager, Project Engineers, Materials Engineers, and Foremen) assigned to the contract to be bid, with their complete qualification and experience data shall be provided. These key personnel must meet the required minimum years of experience set in the **BDS**.

10.5. A List of Contractor's major equipment units, which are owned, leased, and/or under purchase agreements, supported by proof of ownership, certification of availability of equipment from the equipment lessor/vendor for the duration of the project, as the case may be, must meet the minimum requirements for the contract set in the **BDS**.

## **11. Documents Comprising the Bid: Financial Component**

- 11.1. The second bid envelope shall contain the financial documents for the Bid as specified in **Section IX. Checklist of Technical and Financial Documents**.
- 11.2. Any bid exceeding the ABC indicated in paragraph 1 of the **IB** shall not be accepted.
- 11.3. For Foreign-funded procurement, a ceiling may be applied to bid prices provided the conditions are met under Section 31.2 of the 2016 revised IRR of RA No. 9184.

## **12. Alternative Bids**

Bidders shall submit offers that comply with the requirements of the Bidding Documents, including the basic technical design as indicated in the drawings and specifications. Unless there is a value engineering clause in the **BDS**, alternative Bids shall not be accepted.

## **13. Bid Prices**

All bid prices for the given scope of work in the Project as awarded shall be considered as fixed prices, and therefore not subject to price escalation during contract implementation, except under extraordinary circumstances as determined by the NEDA and approved by the GPPB pursuant to the revised Guidelines for Contract Price Escalation guidelines.

## **14. Bid and Payment Currencies**

- 14.1. Bid prices may be quoted in the local currency or tradeable currency accepted by the BSP at the discretion of the Bidder. However, for purposes of bid evaluation, Bids denominated in foreign currencies shall be converted to Philippine currency based on the exchange rate as published in the BSP reference rate bulletin on the day of the bid opening.
- 14.2. Payment of the contract price shall be made in:
  - a. Philippine Pesos.

## **15. Bid Security**

- 15.1. The Bidder shall submit a Bid Securing Declaration or any form of Bid Security in the amount indicated in the **BDS**, which shall be not less than the percentage of the ABC in accordance with the schedule in the **BDS**.
- 15.2. The Bid and bid security shall be valid until **One Hundred Twenty (120) days**. Any bid not accompanied by an acceptable bid security shall be rejected by the Procuring Entity as non-responsive.

## **16. Sealing and Marking of Bids**

Each Bidder shall submit one copy of the first and second components of its Bid.

The Procuring Entity may request additional hard copies and/or electronic copies of the Bid. However, failure of the Bidders to comply with the said request shall not be a ground for disqualification.

If the Procuring Entity allows the submission of bids through online submission to the given website or any other electronic means, the Bidder shall submit an electronic copy of its Bid, which must be digitally signed. An electronic copy that cannot be opened or is corrupted shall be considered non-responsive and, thus, automatically disqualified.

*(Reference must be made to herewith attached **Guidelines to Bidders in Adopting Electronic Submission of Bids**)*

## **17. Deadline for Submission of Bids**

The Bidders shall submit on the specified date and time and either at its physical address or through online submission as indicated in paragraph 7 of the IB.

Submit via <https://tinyurl.com/dswfo3cbupload>

*(Reference must be made to herewith attached **Guidelines to Bidders in Adopting Electronic Submission of Bids**)*

## **18. Opening and Preliminary Examination of Bids**

18.1. The BAC shall open the Bids in public at the time, on the date, and at the place specified in paragraph 9 of the **IB**. The Bidders' representatives who are present shall sign a register evidencing their attendance. In case videoconferencing, webcasting or other similar technologies will be used, attendance of participants shall likewise be recorded by the BAC Secretariat.

In case the Bids cannot be opened as scheduled due to justifiable reasons, the rescheduling requirements under Section 29 of the 2016 revised IRR of RA No. 9184 shall prevail.

18.2. The preliminary examination of Bids shall be governed by Section 30 of the 2016 revised IRR of RA No. 9184.

## **19. Detailed Evaluation and Comparison of Bids**

19.1. The Procuring Entity's BAC shall immediately conduct a detailed evaluation of all Bids rated "*passed*" using non-discretionary pass/fail criteria. The BAC shall consider the conditions in the evaluation of Bids under Section 32.2 of 2016 revised IRR of RA No. 9184.

- 19.2. If the Project allows partial bids, all Bids and combinations of Bids as indicated in the **BDS** shall be received by the same deadline and opened and evaluated simultaneously so as to determine the Bid or combination of Bids offering the lowest calculated cost to the Procuring Entity. Bid Security as required by **ITB** Clause 15 shall be submitted for each contract (lot) separately.
- 19.3. In all cases, the NFCC computation pursuant to Section 23.4.2.6 of the 2016 revised IRR of RA No. 9184 must be sufficient for the total of the ABCs for all the lots participated in by the prospective Bidder.

## **20. Post Qualification**

Within a non-extendible period of five (5) calendar days from receipt by the Bidder of the notice from the BAC that it submitted the Lowest Calculated Bid, the Bidder shall submit its latest income and business tax returns filed and paid through the BIR Electronic Filing and Payment System (eFPS), and other appropriate licenses and permits required by law and stated in the **BDS**.

## **21. Signing of the Contract**

The documents required in Section 37.2 of the 2016 revised IRR of RA No. 9184 shall form part of the Contract. Additional Contract documents are indicated in the **BDS**.

## ***Section III. Bid Data Sheet***

### **Notes on the Bid Data Sheet (BDS)**

The Bid Data Sheet (BDS) consists of provisions that supplement, amend, or specify in detail, information, or requirements included in the ITB found in Section II, which are specific to each procurement.

This Section is intended to assist the Procuring Entity in providing the specific information in relation to corresponding clauses in the ITB and has to be prepared for each specific procurement.

The Procuring Entity should specify in the BDS information and requirements specific to the circumstances of the Procuring Entity, the processing of the procurement, and the bid evaluation criteria that will apply to the Bids. In preparing the BDS, the following aspects should be checked:

- a. Information that specifies and complements provisions of the ITB must be incorporated.
- b. Amendments and/or supplements, if any, to provisions of the ITB as necessitated by the circumstances of the specific procurement, must also be incorporated.

# Bid Data Sheet

ITB Clause										
5.2	<p>For this purpose, contracts similar to the Project refer to contracts which have the same major categories of work, which shall be:</p> <p>Any related civil and architectural works construction; civil engineering projects; and infrastructure projects such construction; improvement; rehabilitation; repair of building interior/ exterior works completed within the ten (10) years from the deadline of bid submission.</p> <p>The prospective bidder must have <b>completed an SLCC</b> that is similar to the contract to be bid, and whose value, adjusted to current prices using the PSA consumer price indices, must be at least fifty percent (50%) of the ABC to be bid supported by the Contractors Performance Evaluation System rating or a certificate of satisfactory rating or certificate of satisfactory completion of the project issued by the owner of the previous completed project.</p>									
7.1	<b>SUBCONTRACTING IS NOT ALLOWED</b>									
10.3	<p><i>In accordance with PCAB BOARD RESOLUTION No. 201 Series of 2017, the minimum required licensed category for this Project is license category:</i></p> <table border="1" style="margin-left: auto; margin-right: auto; border-collapse: collapse;"> <thead> <tr> <th style="text-align: center;">Size Range</th> <th style="text-align: center;">License Category</th> <th style="text-align: center;">Classification</th> </tr> </thead> <tbody> <tr> <td style="text-align: center;">At least Small B</td> <td style="text-align: center;">C &amp; D</td> <td style="text-align: center;">General Engineering / General Building</td> </tr> </tbody> </table>	Size Range	License Category	Classification	At least Small B	C & D	General Engineering / General Building			
Size Range	License Category	Classification								
At least Small B	C & D	General Engineering / General Building								
10.4	<p>The key personnel must meet the required minimum years of experience set</p> <table border="1" style="margin-left: auto; margin-right: auto; border-collapse: collapse;"> <thead> <tr> <th style="text-align: center;">Key Personnel</th> <th style="text-align: center;">General Experience</th> <th style="text-align: center;">Relevant Experience</th> </tr> </thead> <tbody> <tr> <td style="text-align: center;">One(1) Project Engineer</td> <td style="text-align: center;">Must be Licensed Electrical Engineer</td> <td style="text-align: center;">Minimum of Three (3) years of Relevant Experience</td> </tr> <tr> <td style="text-align: center;">One(1) Foreman</td> <td style="text-align: center;">Must be dedicated Foreman per Project</td> <td style="text-align: center;">Minimum of Five (5) years in Electrical Works</td> </tr> </tbody> </table>	Key Personnel	General Experience	Relevant Experience	One(1) Project Engineer	Must be Licensed Electrical Engineer	Minimum of Three (3) years of Relevant Experience	One(1) Foreman	Must be dedicated Foreman per Project	Minimum of Five (5) years in Electrical Works
Key Personnel	General Experience	Relevant Experience								
One(1) Project Engineer	Must be Licensed Electrical Engineer	Minimum of Three (3) years of Relevant Experience								
One(1) Foreman	Must be dedicated Foreman per Project	Minimum of Five (5) years in Electrical Works								
10.5	<p>The minimum major equipment requirements are the following:</p> <table style="margin-left: auto; margin-right: auto;"> <thead> <tr> <th style="text-align: center;"><u>Equipment</u></th> <th style="text-align: center;"><u>Number of Units</u></th> </tr> </thead> <tbody> <tr> <td style="text-align: center;">Service truck (at least ELF)</td> <td style="text-align: center;">One (1)</td> </tr> </tbody> </table>	<u>Equipment</u>	<u>Number of Units</u>	Service truck (at least ELF)	One (1)					
<u>Equipment</u>	<u>Number of Units</u>									
Service truck (at least ELF)	One (1)									
12	No further instruction									
15.1	<p>The bid security shall be in the form of a Bid Securing Declaration or any of the following forms and amounts:</p> <p>a. The amount of not less than 2%, if bid security is in cash,</p>									

	<p>cashier's/manager's check, bank draft/guarantee or irrevocable letter of credit;  b. The amount of not less than 5% if bid security is in Surety Bond.</p>
20	<p>As the case may be, the bidders shall submit a CERTIFIED TRUE COPY of the additional supporting documents during the OPENING BIDS Stage:</p> <p>1. Supporting Documents for the STATEMENT OF THE BIDDER OF ITS SINGLE LARGEST COMPLETED CONTRACT (SLCC);</p> <p>Further, the bidders shall submit a CERTIFIED TRUE COPY of the additional supporting documents during the POST QUALIFICATION Stage:</p> <p>1. Latest income tax returns (ITR) are those covering the immediately preceding year while latest business tax returns (BTR) are those filed within the last six (6) months preceding the date of bid submission, provided that such income and business tax returns is the most recent document that can be produced by the bidder without fault or delay on its part in filing the same with the BIR.</p> <p>Note: Only the latest income and business tax returns filed and paid through the EFPS and printed thru the Tax Return Inquiry facility of the BIR shall be accepted.</p> <p>2. Updated PhilGEPS Certificate of Platinum Membership;  3. Business licenses and permits required by law (Registration Certificate, Mayor's Permit, Tax Clearance &amp; PCAB License);  4. Audited Financial Statements;  5. Key Personnel licenses and Bio-Data;  6. Supporting Documents for the STATEMENT OF THE BIDDER OF ALL ITS ONGOING GOVERNMENT AND PRIVATE CONTRACTS;  7. Supporting Documents for the STATEMENT OF THE BIDDER OF ITS SINGLE LARGEST COMPLETED CONTRACT (SLCC);</p>
20.3	<p>Reference must be made to herewith attached Guidelines to Bidders in Adopting Electronic Submission of Bids</p> <p><b>For Submission of Bids</b></p> <p><b>Step 1:</b> Scan the original copy of the <b>Legal and Technical Requirements</b> and save as PDF, after scanning the original copy of the <b>Legal and Technical Requirements</b>, place the scanned files in one folder with file name "<b>Legal and Technical Documents</b>" and compress the folder using <b>WinRAR Extractor Application</b> with file name "Folder 1 - Legal and Technical Documents", place/set a password on the file;</p> <p><b>Step 2:</b> Scan the original copy of the <b>Financial Requirements</b> and save as PDF, after scanning the original copy of the <b>Financial Requirements</b>, place the scanned files in one folder with file name "<b>Financial Requirements</b>" and compress the folder using <b>WinRAR Extractor Application</b> with file name "<b>Folder 2 – Financial Documents</b>", place/set a password on the file;</p> <p><b>In case of modification of bids</b> by the bidder, the bidder shall use the file name for the main folder "<b>DSWD-FOIII Bidding No. __ (Name of</b></p>

**Bidder) - Modification”**

The original bid submitted shall not be retrieved but a modified bid shall be submitted to the BAC Secretariat official email provided that it is equally secured by password, properly identified, and submitted on or before the set deadline. The bidder shall use the following file names for the PDF files:

➤ For Legal and Technical Requirements: **“Folder 1 – Legal and Technical Documents – Modification”**

➤ For Financial Requirements: **“Folder 2 - Financial Documents - Modification”**

**Important:** Passwords shall bear a unique combination for each file. Same passwords for all files are strictly not allowed. Please see attached **ANNEX** for your guidance.

**Step 3:** Submit your bids to <https://tinyurl.com/dswfo3cbupload> on or before the set deadline with Subject: “DSWD-FOIII Bidding No. - (Name of Bidder)”.

**Step 4:** After submission of your bids, wait for an acknowledgement of BAC via email for the confirmation of your submitted bids indicating the Date and Time of your submission, and also the link for the Opening of Bids will be sent to your registered email. Please print the confirmation sent by the BAC as proof of your submission.

**Important:** All bids submitted after the deadline will **NOT** be considered in the bid opening.

**NOTE: ALL PASSWORDS must be disclosed by the bidder’s representative ONLY DURING THE SCHEDULED DATE and TIME for the OPENING OF BIDS stated herein when prompted by the BAC Secretariat.**

**For Opening of Bids**

**Step 1:** Open the email and access the link provided by the Secretariat to enter in the video conference. Wait for the confirmation from the BAC Secretariat to enter the meeting room.

**Step 2:** When prompted, disclose in the chatbox the password to the password-protected RAR folder. The BAC Secretariat will prompt you to disclose the password for the document containing the **Legal and Technical Requirements**. If you are present, the BAC Secretariat will ask in the chatbox of the Google Meet video conferencing room for the corresponding password during the bid opening itself.

**Step 3:** Should the **Legal and Technical Requirements** be declared as



	<p>"PASSED", you will be prompted to disclose the password for the PDF document containing the <b>Financial Requirements</b>. You must respond promptly.</p> <p><b>Important:</b> If you are not present in the online meeting in Google Meet, the Secretariat will send you an inquiry for such password via text message to your registered mobile number. You are given a minimum of five (5) minutes to respond. Should you not respond with the password when prompted, the BAC shall move on to the next bid, if any. If there are no other bids to be considered, the Secretariat shall ask again via text message for the password, and you are given another five (5) minutes to respond. Should you fail to respond within the allotted time, your submitted bid will no longer be considered.</p>
21	<p>Additional contract documents relevant to the Project that may be required by existing laws and/or the Procuring Entity, such as construction schedule and S-curve, manpower schedule, construction methods, equipment utilization schedule, construction safety and health program approved by the DOLE, and other acceptable tools of project scheduling.</p>

## ***Section IV. General Conditions of Contract***

### **Notes on the General Conditions of Contract**

The General Conditions of Contract (GCC) in this Section, read in conjunction with the Special Conditions of Contract in Section V and other documents listed therein, should be a complete document expressing all the rights and obligations of the parties.

Matters governing performance of the Contractor, payments under the contract, or matters affecting the risks, rights, and obligations of the parties under the contract are included in the GCC and Special Conditions of Contract.

Any complementary information, which may be needed, shall be introduced only through the Special Conditions of Contract.

## 1. Scope of Contract

This Contract shall include all such items, although not specifically mentioned, that can be reasonably inferred as being required for its completion as if such items were expressly mentioned herein. All the provisions of RA No. 9184 and its 2016 revised IRR, including the Generic Procurement Manual, and associated issuances, constitute the primary source for the terms and conditions of the Contract, and thus, applicable in contract implementation. Herein clauses shall serve as the secondary source for the terms and conditions of the Contract.

This is without prejudice to Sections 74.1 and 74.2 of the 2016 revised IRR of RA No. 9184 allowing the GPPB to amend the IRR, which shall be applied to all procurement activities, the advertisement, posting, or invitation of which were issued after the effectivity of the said amendment.

## 2. Sectional Completion of Works

If sectional completion is specified in the **Special Conditions of Contract (SCC)**, references in the Conditions of Contract to the Works, the Completion Date, and the Intended Completion Date shall apply to any Section of the Works (other than references to the Completion Date and Intended Completion Date for the whole of the Works).

## 3. Possession of Site

3.1 The Procuring Entity shall give possession of all or parts of the Site to the Contractor based on the schedule of delivery indicated in the **SCC**, which corresponds to the execution of the Works. If the Contractor suffers delay or incurs cost from failure on the part of the Procuring Entity to give possession in accordance with the terms of this clause, the Procuring Entity's Representative shall give the Contractor a Contract Time Extension and certify such sum as fair to cover the cost incurred, which sum shall be paid by Procuring Entity.

3.2 If possession of a portion is not given by the above date, the Procuring Entity will be deemed to have delayed the start of the relevant activities. The resulting adjustments in contract time to address such delay may be addressed through contract extension provided under Annex "E" of the 2016 revised IRR of RA No. 9184.

## 4. The Contractor's Obligations

The Contractor shall employ the key personnel named in the Schedule of Key Personnel indicating their designation, in accordance with **ITB** Clause 10.3 and specified in the **BDS**, to carry out the supervision of the Works.

The Procuring Entity will approve any proposed replacement of key personnel only if their relevant qualifications and abilities are equal to or better than those of the personnel listed in the Schedule.

## **5. Performance Security**

- 5.1. Within ten (10) calendar days from receipt of the Notice of Award from the Procuring Entity but in no case later than the signing of the contract by both parties, the successful Bidder shall furnish the performance security in any of the forms prescribed in Section 39 of the 2016 revised IRR.
- 5.2. The Contractor, by entering into the Contract with the Procuring Entity, acknowledges the right of the Procuring Entity to institute action pursuant to RA No. 3688 against any subcontractor be they an individual, firm, partnership, corporation, or association supplying the Contractor with labor, materials and/or equipment for the performance of this Contract.

## **6. Site Investigation Reports**

The Contractor, in preparing the Bid, shall rely on any Site Investigation Reports referred to in the SCC supplemented by any information obtained by the Contractor.

## **7. Warranty**

- 7.1. In case the Contractor fails to undertake the repair works under Section 62.2.2 of the 2016 revised IRR, the Procuring Entity shall forfeit its performance security, subject its property(ies) to attachment or garnishment proceedings, and perpetually disqualify it from participating in any public bidding. All payables of the GOP in his favor shall be offset to recover the costs.
- 7.2. The warranty against Structural Defects/Failures, except that occasioned-on force majeure, shall cover the period from the date of issuance of the Certificate of Final Acceptance by the Procuring Entity. Specific duration of the warranty is found in the SCC.

## **8. Liability of the Contractor**

Subject to additional provisions, if any, set forth in the SCC, the Contractor's liability under this Contract shall be as provided by the laws of the Republic of the Philippines.

If the Contractor is a joint venture, all partners to the joint venture shall be jointly and severally liable to the Procuring Entity.

## **9. Termination for Other Causes**

Contract termination shall be initiated in case it is determined *prima facie* by the Procuring Entity that the Contractor has engaged, before, or during the implementation of the contract, in unlawful deeds and behaviors relative to contract acquisition and implementation, such as, but not limited to corrupt, fraudulent, collusive, coercive, and obstructive practices as stated in ITB Clause 4.

## **10. Dayworks**

Subject to the guidelines on Variation Order in Annex “E” of the 2016 revised IRR of RA No. 9184, and if applicable as indicated in the **SCC**, the Dayworks rates in the Contractor’s Bid shall be used for small additional amounts of work only when the Procuring Entity’s Representative has given written instructions in advance for additional work to be paid for in that way.

## **11. Program of Work**

11.1. The Contractor shall submit to the Procuring Entity’s Representative for approval the said Program of Work showing the general methods, arrangements, order, and timing for all the activities in the Works. The submissions of the Program of Work are indicated in the **SCC**.

11.2. The Contractor shall submit to the Procuring Entity’s Representative for approval an updated Program of Work at intervals no longer than the period stated in the **SCC**. If the Contractor does not submit an updated Program of Work within this period, the Procuring Entity’s Representative may withhold the amount stated in the **SCC** from the next payment certificate and continue to withhold this amount until the next payment after the date on which the overdue Program of Work has been submitted.

## **12. Instructions, Inspections and Audits**

The Contractor shall permit the GOP or the Procuring Entity to inspect the Contractor’s accounts and records relating to the performance of the Contractor and to have them audited by auditors of the GOP or the Procuring Entity, as may be required.

## **13. Advance Payment**

The Procuring Entity shall, upon a written request of the Contractor which shall be submitted as a Contract document, make an advance payment to the Contractor in an amount not exceeding fifteen percent (15%) of the total contract price, to be made in lump sum, or at the most two installments according to a schedule specified in the **SCC**, subject to the requirements in Annex “E” of the 2016 revised IRR of RA No. 9184.

## **14. Progress Payments**

The Contractor may submit a request for payment for Work accomplished. Such requests for payment shall be verified and certified by the Procuring Entity’s Representative/Project Engineer. Except as otherwise stipulated in the **SCC**, materials and equipment delivered on the site but not completely put in place shall not be included for payment.

## **15. Operating and Maintenance Manuals**

- 15.1. If required, the Contractor will provide “as built” Drawings and/or operating and maintenance manuals as specified in the **SCC**.
- 15.2. If the Contractor does not provide the Drawings and/or manuals by the dates stated above, or they do not receive the Procuring Entity’s Representative’s approval, the Procuring Entity’s Representative may withhold the amount stated in the **SCC** from payments due to the Contractor.

## ***Section V. Special Conditions of Contract***

### **Notes on the Special Conditions of Contract**

Similar to the BDS, the clauses in this Section are intended to assist the Procuring Entity in providing contract-specific information in relation to corresponding clauses in the GCC found in Section IV.

The Special Conditions of Contract (SCC) complement the GCC, specifying contractual requirements linked to the special circumstances of the Procuring Entity, the Procuring Entity's country, the sector, and the Works procured. In preparing this Section, the following aspects should be checked:

- a. Information that complements provisions of the GCC must be incorporated.
- b. Amendments and/or supplements to provisions of the GCC as necessitated by the circumstances of the specific purchase, must also be incorporated.

However, no special condition which defeats or negates the general intent and purpose of the provisions of the GCC should be incorporated herein.

# Special Conditions of Contract

GCC Clause									
2	Completion Date from such date identified in the Pre-Construction / Civil Work Conference or THIRTY-FIVE (35) CALENDAR DAYS from issuance of the Notice to Proceed.								
4.1	The Procuring Entity shall give possession of the site to the Contractor <b>within seven (7) calendar days from receipt of NTP.</b>								
6	The site investigation report needed shall be the Site Ocular Inspection Report.								
7.2	As may be applicable: Reference: Section 62.2.3.2 of 2016 IRR of RA 9184.								
10	Dayworks are applicable at the rate shown in the Contractor's original Bid.								
11.1	The Contractor shall submit the Program of Work to the Procuring Entity's Representative within <b>Five (5) working days</b> of delivery of the Notice of Award.								
13	<b>NO ADVANCE PAYMENT SHALL APPLY</b>								
	The Schedule of Payment is as follows: <table border="1" style="width: 100%; margin-top: 10px;"> <thead> <tr> <th style="text-align: center;">Payment Tranches</th> <th style="text-align: center;">Outputs/ Deliverables</th> </tr> </thead> <tbody> <tr> <td>1st Tranche: 15% payment of the total contract cost less 10% Retention</td> <td>Must be Fifteen Percent (15 %) of project completion/ physical accomplishment with the submission of Billing Statement, Progress/Accomplishment Report, Statement of Work Accomplished, Progress Photos, and Narrative Report.</td> </tr> <tr> <td>2nd Tranche: 35 % payment of the total contract cost less 10% Retention</td> <td>Must be Fifty Percent (50 %) of project completion/ physical accomplishment with the submission of Billing Statement, Progress/Accomplishment Report, Statement of Work Accomplished, Progress Photos, and Narrative Report.</td> </tr> <tr> <td>3rd Tranche: 50 % payment of the contract cost less 10% Retention</td> <td>Must be Hundred Percent (100%) physical completed Upon with submission of Billing Statement, Contractor's accomplishment reports, Statement of Work Accomplished, Progress Photos, Narrative report, Contractor's certificate of completion, contractors warranty security,</td> </tr> </tbody> </table>	Payment Tranches	Outputs/ Deliverables	1st Tranche: 15% payment of the total contract cost less 10% Retention	Must be Fifteen Percent (15 %) of project completion/ physical accomplishment with the submission of Billing Statement, Progress/Accomplishment Report, Statement of Work Accomplished, Progress Photos, and Narrative Report.	2nd Tranche: 35 % payment of the total contract cost less 10% Retention	Must be Fifty Percent (50 %) of project completion/ physical accomplishment with the submission of Billing Statement, Progress/Accomplishment Report, Statement of Work Accomplished, Progress Photos, and Narrative Report.	3rd Tranche: 50 % payment of the contract cost less 10% Retention	Must be Hundred Percent (100%) physical completed Upon with submission of Billing Statement, Contractor's accomplishment reports, Statement of Work Accomplished, Progress Photos, Narrative report, Contractor's certificate of completion, contractors warranty security,
Payment Tranches	Outputs/ Deliverables								
1st Tranche: 15% payment of the total contract cost less 10% Retention	Must be Fifteen Percent (15 %) of project completion/ physical accomplishment with the submission of Billing Statement, Progress/Accomplishment Report, Statement of Work Accomplished, Progress Photos, and Narrative Report.								
2nd Tranche: 35 % payment of the total contract cost less 10% Retention	Must be Fifty Percent (50 %) of project completion/ physical accomplishment with the submission of Billing Statement, Progress/Accomplishment Report, Statement of Work Accomplished, Progress Photos, and Narrative Report.								
3rd Tranche: 50 % payment of the contract cost less 10% Retention	Must be Hundred Percent (100%) physical completed Upon with submission of Billing Statement, Contractor's accomplishment reports, Statement of Work Accomplished, Progress Photos, Narrative report, Contractor's certificate of completion, contractors warranty security,								



	<p>4th Final Tranche: 10 % payment of the total contract price (10% Retention Money)</p>	<p>contractors request for acceptance and turn-over certificate; and Notarized certificate of warranty.</p> <p>Must be one (1) month and without damage/defect of installed items and Upon Submission of Contractors warranty security issued by the private insurance company, Notarized Certificate of Warranty.</p>
	<p><b>LIQUIDATED DAMAGES</b></p> <p>In accordance with Section 68 of the 2016 Revised IRR of Republic Act No. 9184, liquidated damages which shall be payable by the contractor in case of breach thereof shall be as follows:  For the procurement of Goods, Infrastructure Projects and Consulting Services, the amount of the liquidated damages shall be at least equal to one-tenth of one percent (0.001) of the cost of the unperformed portion for every day of delay.  Once the cumulative amount of liquidated damages reaches ten percent (10%) of the amount of the contract, the Procuring Entity may rescind or terminate the contract, without prejudice to other courses of action and remedies available under the circumstances</p>	
26.1	<p>Non-compliance by the bidder and its implementation partner/s with the provisions of Republic Act No. 10173, known as the “Data Privacy Act of 2012” and its Implementing Rules and Regulations is also considered as “Unlawful Act”.</p>	
	<p><b>RESPONSIBILITY OF DSWD FO III DURING CONTRACT IMPLEMENTATION</b></p> <p>DSWD authorized representative shall approve the Contractor’s submissions (brochure of the equipment to be supplied including all its accessories, shop drawings for its installation and a list of materials with description and specifications) to be used in the project within seven (7) calendar days after issuance of Notice to Proceed. All equipment, materials and other components installed without prior approval of DSWD shall be at the risk of rejection.</p> <p>39</p> <p>In the implementation of work, DSWD or its representative shall not be responsible for any accident such as death, injuries and diseases received by the contractor or any of its employee or laborers. Likewise, the DSWD shall not be responsible for any loss or damage of materials, tools, equipment delivered on the job site. Damages on the DSWD properties and equipment caused by the Supplier shall be replaced/repaid at its own expense to the satisfaction of the GSIS. In the event of failure of</p>	

	repair and or replacement of the same, DSWD shall deduct the cost of such repairs from the payment due to the Supplier.
--	---

## ***Section VI. Specifications***

### **Notes on Specifications**

A set of precise and clear specifications is a prerequisite for Bidders to respond realistically and competitively to the requirements of the Procuring Entity without qualifying or conditioning their Bids. In the context of international competitive bidding, the specifications must be drafted to permit the widest possible competition and, at the same time, present a clear statement of the required standards of workmanship, materials, and performance of the goods and services to be procured. Only if this is done will the objectives of economy, efficiency, and fairness in procurement be realized, responsiveness of Bids be ensured, and the subsequent task of bid evaluation facilitated. The specifications should require that all goods and materials to be incorporated in the Works be new, unused, of the most recent or current models, and incorporate all recent improvements in design and materials unless provided otherwise in the Contract.

Samples of specifications from previous similar projects are useful in this respect. The use of metric units is mandatory. Most specifications are normally written specially by the Procuring Entity or its representative to suit the Works at hand. There is no standard set of Specifications for universal application in all sectors in all regions, but there are established principles and practices, which are reflected in these PBDs.

There are considerable advantages in standardizing General Specifications for repetitive Works in recognized public sectors, such as highways, ports, railways, urban housing, irrigation, and water supply, in the same country or region where similar conditions prevail. The General Specifications should cover all classes of workmanship, materials, and equipment commonly involved in construction, although not necessarily to be used in a particular Works Contract. Deletions or addenda should then adapt the General Specifications to the particular Works.

Care must be taken in drafting specifications to ensure that they are not restrictive. In the specification of standards for goods, materials, and workmanship, recognized international standards should be used as much as possible. Where other particular standards are used, whether national standards or other standards, the specifications should state that goods, materials, and workmanship that meet other authoritative standards, and which ensure substantially equal or higher quality than the standards mentioned, will also be acceptable. The following clause may be inserted in the SCC.

#### **Sample Clause: Equivalency of Standards and Codes**

Wherever reference is made in the Contract to specific standards and codes to be met by the goods and materials to be furnished, and work performed or tested, the provisions of

the latest current edition or revision of the relevant standards and codes in effect shall apply, unless otherwise expressly stated in the Contract. Where such standards and codes are national, or relate to a particular country or region, other authoritative standards that ensure a substantially equal or higher quality than the standards and codes specified will be accepted subject to the Procuring Entity's Representative's prior review and written consent. Differences between the standards specified and the proposed alternative standards shall be fully described in writing by the Contractor and submitted to the Procuring Entity's Representative at least twenty-eight (28) days prior to the date when the Contractor desires the Procuring Entity's Representative's consent. In the event the Procuring Entity's Representative determines that such proposed deviations do not ensure substantially equal or higher quality, the Contractor shall comply with the standards specified in the documents.

These notes are intended only as information for the Procuring Entity or the person drafting the Bidding Documents. They should not be included in the final Bidding Documents.

## TERMS OF REFERENCE

### A. Background/Rationale

. The **AMOR Village** is a residential care facility designed to provide healing and empowerment to abandoned, neglected and abused children and children with disabilities. It is a 24/7 residential facility a total bed capacity of 120. To date, the Center has 116 residents with special needs to date and is expecting new admissions these coming months.

The **AMOR Village** primarily serves children with special needs who abandoned, neglected, abused and victims of domestic violence and ages 6 to 17 years old, both male and female. However, the age will be classified according to their mental age. Catering children with special needs entails many challenges wherein the staffs are trying to cope up to be effective workers at all times. Priority clients for admission are the abandoned children with special needs. Case Categories, such as: A. Persons with Physical Impairment (Orthopedically Handicapped Visual Impaired, Hearing Impaired and other disabilities such as speech defect, hunchback, cleft palate); B. Persons with features of Neuro-Developmental Disorders (Persons with Intellectual Disability (ID), Persons with Autism Spectrum Disorder (ASD), Persons with Attention Deficit Hyperactive Disorder (ADHD), Persons with Specific Learning Disorder, Persons with Down Syndrome, an Persons with Cerebral Palsy).

The **DSWD AMOR VILLAGE** is the only government facility for special children in Region 3. It is compose of 19 buildings with 2 big dormitories catering 40 cases for boys and 40 girls dormitory .We have 2 new cottages for extra ordinary cases the cerebral palsy, multi –disability case that can accommodate 20 cases while the 2 extension rooms could also accommodate 20 cases. Our infirmary has separate buildings with different amenities to be installed.

In addition to meeting the requirements for achieving the Centers of Excellence accreditation and ISO Certification, the procurement projects that will be charged against the Regular Fund

will also stimulate collaborative workplace, enhanced employee productivity and efficiency, and increased physical protection to the clientele. The CRCFs deem that the realization of these procurement projects will be tantamount to purveying solutions to the astounding problems involving the inadequacy and obsolescence of their respective equipment, supplies, furniture and structures.

The Bureau of Fire Protection (BFP) is a government fire service that is responsible for the prevention and suppression of all destructive fires in the Philippines. The BFP has the obligation to ensure public safety on buildings, houses, establishments, and other similar structures from any form of a disastrous fire. During the renewal of the

Fire Safety permit of the DSWD AMOR Village, the Bureau of Fire and Protection of the Municipality of Anao, Province of Tarlac headed by SFO4 Alexander G. Calpatura, one of the findings was “No Fire detection and Alarm System”. This is to monitor any fire that might happen and therefore send triggers and alarms to everyone to prevent further damage and casualties. The system gives an early warning of the threat and allows enough time to evacuate the premises and call the authorities before the fire gets out of control. Fire alarm are vital part of any home or center and there are even laws stating that every structure, small or large, must have alarm system.

## **B. Objectives**

1. To achieve the Center of Excellence accreditation status.
2. To improve the quality of residential care services provided to the clients.
3. To address and mitigate the requirement for the Fire and Safety Inspection Certificate

## **C. Scope of Works**

The Protective Services Division – Center Based Services Section is responsible for ensuring the compliance of 7s Good Housekeeping in order to achieve the organization's vision and goal. Thus, in order to ensure the section's contribution in the achievement of the said vision, the proposal of Supply, Installation and Testing of Addressable Fire Detection and Alarm System (FDAS) is being made. The following Scope of Works is as follows:

### **I. GENERAL REQUIREMENTS**

1. Mobilization/Demobilization
2. Temporary Facilities
3. As-built Plans duly signed and sealed by Professional Electrical Engineer

### **I. CONSTRUCTION WORKS**

1. Electrical Works
  - 1.1. Conduits Boxes and Fittings
  - 1.2. Wires and Wiring Devices
  
2. Mechanical Works
  - 2.1. Fire Alarm Control Panel
  - 2.2. Smoke Detector
  - 2.3. Heat Detector
  - 2.4. Manual Call Point
  - 2.5. Horn Strobe
  - 2.6. Annunciator

## **D. Schedule of Works**

The Project Duration is Thirty Five (35) Calendar days and will commence after the pre-construction meeting.

**E. Qualification, Duties and Responsibilities of the Service Provider**

See Contractor's Terms of References

**CONTRACTOR'S TERMS OF REFERENCE**

Name of Project: <b>SUPPLY,INSTALLATION AND TESTING OF ADDRESSABLE FIRE DETECTION AND ALARM SYSTEM(FDAS)</b>		Location: <b>AMOR VILLAGE,SAN FRANCISCO EAST,ANAO, TARLAC CITY</b>	
Total Project Cost:	<b>PHP</b>	Project Duration:	<b>35 CALENDAR DAYS</b>
Source of Fund:	<b>CAPITAL OUTLAY-CURRENT FUND 2023-SAVINGS</b>	Mode of Procurement:	<b>COMPETITIVE BIDDING</b>
Date of POW:	<b>Calendar Year 2024</b>	Source of Manpower:	<b>OUTSOURCE</b>

**GENERAL CONDITION AND REQUIREMENTS**

**A.) Contractor's Qualification(s)**

- 1.) Service Provider/ Contractor shall have a Single Largest Contract with similar project contract and scope such as construction, improvement/ rehabilitation/ repair of building interior/ exterior works completed within the Ten(10) years from the deadline of bid submission, whose the value of contract amount must at least fifty percent (50%) of the ABC with supported by the Contractors Performance Evaluation System rating or a certificate of satisfactory rating or certificate of satisfactory completion of the project issued by the owner of the previous completed project.
- 2.) Service Provider/ Contractor required license Category for the Philippines Contractor's Accreditation Board Circular No. 201, Series of 2017

<b>Size Range</b>	<b>License Category</b>	<b>Classification</b>
At least Small B	C & D	General Engineering/ General Building

**B.) Contractor's Working Hours**

- 1.) All normal works for regular days of this contract shall be performed during office hours (8:00 am to 5:00 pm), including Weekends, Holiday and Special Holiday with proper coordination/approval to RPMT Implementing Team.
- 2.) The Contractor/Service Provider shall be required to furnish safe, proper and sufficient lighting arrangement during overnight works.

- 3.) Weekends/holidays shall deploy a maximum number of manpower based on the submitted Contractors Schedule, just to catch-up the possible delays due to possible stoppage instructed by RPMT Implementing Team.

**C.) Contractor's Responsibilities and Conditions**

- 1.) Contractor/Service Provider shall request a Pre-Construction Meeting with RPMT Engineer and Center head before the start of work.
- 2.) Contractor shall control the generation of dust and flying particles from the operation and shall provide a temporary closure to prevent creation of nuisance to the adjacent offices/rooms;
- 3.) Contractor/ Service Provider shall submit own construction schedule, manpower deployment schedule, equipment's/ tools schedule, list of manpower to be deployed and Project Site organizational structure within five (5) days upon received of Notice of Award;
- 4.) Contractor/Service provider shall assign project engineer/project architect from the start until completion stage;
- 5.) Contractor/Service provider shall coordinate to the RPMT Implementing Team all the execution works;
- 6.) Contractor/Service provider shall provide warning signages, project signboard, contractors project log book;
- 7.) Contractor/Service provider's workers shall sign on the logbook before entering the premises as reference of the DSWD-Regional Center security guards.
- 8.) Contractor/Service provider shall provide/submit Statement of Works Accomplishment, Progress Photos and Narrative report as requirement of the billing request;
- 9.) Contractor/Service provider shall submit weekly progress reports with attached progress photos to RPMT Implementing team;
- 10.) Contractor/Service provider shall provide delivery receipt or list of all materials brought inside the compound including the list of equipment and tools;
- 11.) Contractor/Service provider shall provide complete uniform with ID and basic PPE for all the construction worker and personnel; and
- 12.) The Contractor/Service Provider shall ensure the sufficient number of manpower to complete The project within the agreed timeline/duration. The key personnel requirements shall be as follows;

Key Personnel	Requirements	Experience
One(1) Project Engineer	One(1) Licensed Electrical Engineer	Minimum of Three(3) years of Relevant Experience
One(1) Foreman	Dedicated Foreman per Project	Minimum of Five(5) years in Electrical Works



- 13.) For each project they bid on, the successful contractor/service provider is responsible for obtaining all necessary licenses and permits.
- 14.) The Contractor/Service Provider shall strictly comply/observe the Construction Safety Guidelines for the Implementation of All Infrastructure Projects during the Covid-19 Public Health Crisis as per DPWH Department Order No. 35 Series of 2020. (see Annex D)
- 15.) Except for the service truck, which may be used in a different center, the contractor's specified equipment may not be used again if they have won another project with a different center and may only be utilized if they have won at least two projects within the same center. In the event that the equipment is rented, the contractor or service provider shall submit a copy of the lease agreement.
- 16.) The backhoe ratio will rely on the evaluation of our designated RPMT engineers, but if they do not make an assessment, the required ratio is 1:1. The specified equipment of the contractor may only be used if they have won at least two projects with the same center, and may not be used again if they have won another project with a different center. The contractor or service provider must produce a copy of the lease agreement if the equipment is rented.

**D.) Recommended Terms of Payment**

- 1.) The Payment for this project shall be made upon completion of the following activity/scope of works:

<b>Payment Tranches</b>	<b>Outputs/ Deliverables</b>
1st Tranche: 15% payment of the total contract cost less 10% Retention	Must be Fifteen Percent (15 %) of project completion/ physical accomplishment with the submission of Billing Statement, Progress/Accomplishment Report, Statement of Work Accomplished, Progress Photos, and Narrative Report.
2nd Tranche: 35 % payment of the total contract cost less 10% Retention	Must be Fifty Percent (50 %) of project completion/ physical accomplishment with the submission of Billing Statement, Progress/Accomplishment Report, Statement of Work Accomplished, Progress Photos, and Narrative Report.
3rd Tranche: 50 % payment of the contract cost less 10% Retention	Must be Hundred Percent (100%) physical completed Upon with submission of Billing Statement, Contractor's accomplishment reports, Statement of Work Accomplished, Progress Photos, Narrative report, Contractor's certificate of completion, contractors warranty security, contractors request for acceptance and turn-over certificate; and Notarized certificate of warranty.

4th Final Tranche: 10 % payment of the total contract price (10% Retention Money)

Must be one (1) month and without damage/defect of installed items and Upon Submission of Contractors warranty security issued by the private insurance company, Notarized Certificate of Warranty.

**E.) Contractor's Minimum Major Equipment and Tools Requirements**

- 1.) List of Minimum major equipment/ tools requirement are the following

				1-unit Service Truck (atleast ELF)		

**F.) Other General Requirements**

- 1 All dimensions/level etc. indicated in the drawing plans are to be verified on the site;
- 2 All materials are subjected for the approval by the End- user/RPMT Project Engineer;
- 3 Any discrepancies, either between written dimensions and site dimensions shall be brought to the RPMT office before executing the works;
- 4 All equipment, tools, scaffolding and other personnel needed shall be provided by the service provider/contractor;
- 5 Removal, dismantling and demolition work shall be coordinated and requested to the RPMT Implementing Team;
- 6 All waste materials shall be turned over to the RPMT Implementing Team with proper documentation;
- 7 No additional/extra cost to be claimed/charged by the Contractor for the Construction Works alone other than those expressly approved by the Procuring Entity
- 8 All works shall comply with the National Building Code of the Philippines, Fire Code of the Philippines, Philippine Electrical Code and Department rules and Regulations and other relevant laws, rules and regulations.

**4.2 To ensure the timely implementation of infrastructure projects and effective management of the performance of contractors, the following calibrated actions in response to delays in the implementation of infrastructure projects are hereby adopted:**

**4.2.1 Negative slippage of five percent (5%)** - The contractor shall be given a warning and be required to:

4.2.1.1 Submit a detailed "catch-up" program every two weeks in order to eliminate the slippage and to restore the project to its original schedule;

4.2.1.2 Accelerate work and identify specific physical targets to be accomplished over a definite period of time; and

4.2.1.3 Provide additional input resources such as the following; money, manpower, materials, equipment, and management, which shall be mobilized for this action.

**4.2.2 Negative slippage of ten percent (10%)** -

The contractor shall be issued a final warning and be required to come-up with revised detailed "catch-up" program with weekly physical targets together with the required additional input resources.

The implementing unit shall intensify on-site supervision and evaluation of the project performance to at least once a week and prepare contingency plans for a possible termination of the contract or take-over of the work by administration or contract.

**4.2.3 Negative slippage of fifteen percent (15%)** -

The contractor shall be issued a final warning and be required to come-up with a revised detailed "catch-up" program with weekly physical targets together with the required additional input resources.

The implementing unit shall intensify on-site supervision and evaluation of the project performance to at least once a week and prepare contingency plans for a possible termination of the contract or take-over of the work by administration or contract.

## *Section VII. Drawings*

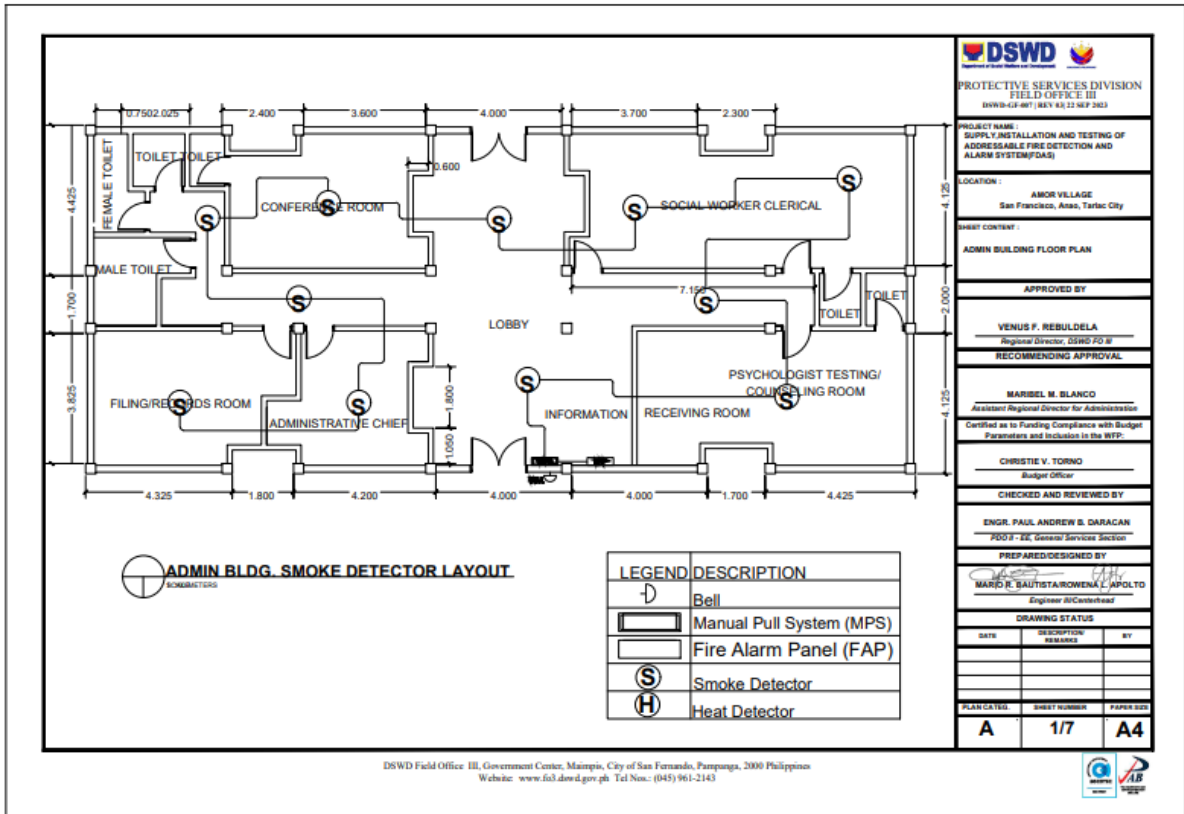

DSWD Field Office III, Government Center, Mainpin, City of San Fernando, Panganga, 2000 Philippines  
 Website: www.foi3.dswd.gov.ph Tel No.: (045) 961-2143

**DSWD**  
 PROTECTIVE SERVICES DIVISION  
 FIELD OFFICE III  
 (BWB-GP-07) (REV 4) 22 SEP 2023

PROJECT NAME:  
 SUPPLY, INSTALLATION AND TESTING OF  
 ADDRESSABLE FIRE DETECTION AND  
 ALARM SYSTEM (FDAS)

LOCATION:  
 AMOR VILLAGE  
 San Francisco, Anao, Tarlac City

SHEET CONTENT:  
 ADMIN BUILDING FLOOR PLAN

APPROVED BY  
 VENUS F. REBULDELA  
 Regional Director, DSWD FO III

RECOMMENDING APPROVAL  
 MARIBEL M. BLANCO  
 Assistant Regional Director for Administration  
 Certified as to Funding Compliance with Budget  
 Parameters and Inclusion in the BFP.

CHECKED AND REVIEWED BY  
 ENGR. PAUL ANDREW S. DARACAN  
 PDD 3 - EE, Manager Service Section

PREPARED/DESIGNED BY  
 MARIO R. BAUTISTA/ROWENA L. APOLTO  
 Engineer III/Consultant

DRAWING STATUS

DATE	DESCRIPTION	BY

PLAN CATG: A SHEET NUMBER: 1/7 PAPER SIZE: A4

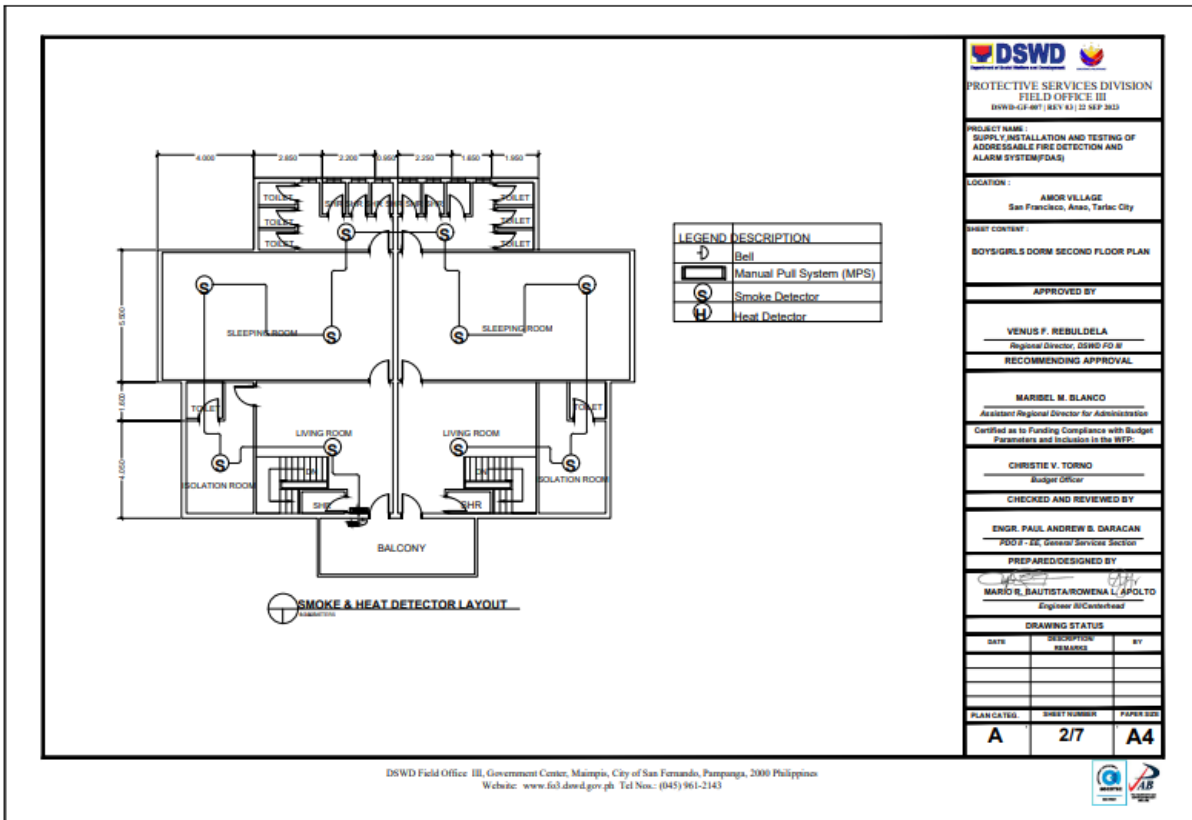

DSWD Field Office III, Government Center, Mainpin, City of San Fernando, Panganga, 2000 Philippines  
 Website: www.foi3.dswd.gov.ph Tel No.: (045) 961-2143

**DSWD**  
 PROTECTIVE SERVICES DIVISION  
 FIELD OFFICE III  
 (BWB-GP-07) (REV 4) 22 SEP 2023

PROJECT NAME:  
 SUPPLY, INSTALLATION AND TESTING OF  
 ADDRESSABLE FIRE DETECTION AND  
 ALARM SYSTEM (FDAS)

LOCATION:  
 AMOR VILLAGE  
 San Francisco, Anao, Tarlac City

SHEET CONTENT:  
 BOYS/GIRLS DORM SECOND FLOOR PLAN

APPROVED BY  
 VENUS F. REBULDELA  
 Regional Director, DSWD FO III

RECOMMENDING APPROVAL  
 MARIBEL M. BLANCO  
 Assistant Regional Director for Administration  
 Certified as to Funding Compliance with Budget  
 Parameters and Inclusion in the BFP.

CHECKED AND REVIEWED BY  
 ENGR. PAUL ANDREW S. DARACAN  
 PDD 3 - EE, Manager Service Section

PREPARED/DESIGNED BY  
 MARIO R. BAUTISTA/ROWENA L. APOLTO  
 Engineer III/Consultant

DRAWING STATUS

DATE	DESCRIPTION	BY

PLAN CATG: A SHEET NUMBER: 2/7 PAPER SIZE: A4

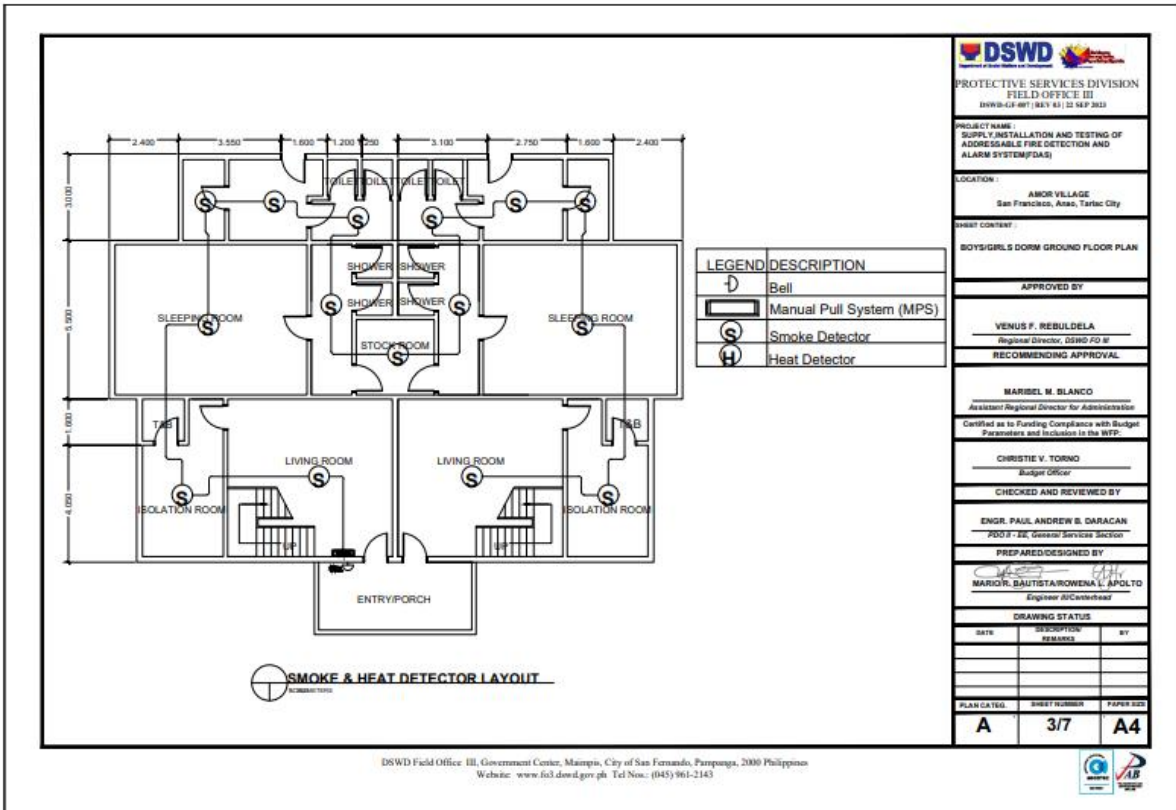

DSWD Field Office III, Government Center, Marikina, City of San Fernando, Pasig, 2000 Philippines  
Website: www.fid.dswd.gov.ph Tel No.: (045)961-2143

**DSWD**  
DEPARTMENT OF SOCIAL WELFARE AND HUMAN DEVELOPMENT

**PROTECTIVE SERVICES DIVISION**  
FIELD OFFICE III  
DSWB-CF-WF (REV 4), 22 SEP 2013

PROJECT NAME:  
SUPPLY, INSTALLATION AND TESTING OF ADDRESSABLE FIRE DETECTION AND ALARM SYSTEM (DAS)

LOCATION:  
AMOR VILLAGE  
San Francisco, Anaa, Tarlac City

SHEET CONTENT:  
BOYS/GIRLS DORM GROUND FLOOR PLAN

APPROVED BY:  
VENUS F. REBULDELA  
Regional Director, DSWD FO III  
RECOMMENDING APPROVAL

MARIEL M. BLANCO  
Assistant Regional Director for Administration  
Certified as to Funding Compliance with Budget Parameters and Inclusion in the WFP.

CHRISTIE V. TORNO  
Budget Officer

CHECKED AND REVIEWED BY:  
ENGR. PAUL ANDREW B. DARACAN  
2007-EE, General Services Section

PREPARED/DESIGNED BY:  
MARGOL BAUTISTA-ROVENA L. APOLTO  
Engineer/IC/Contractor

DRAWING STATUS

DATE	DESCRIPTION	BY

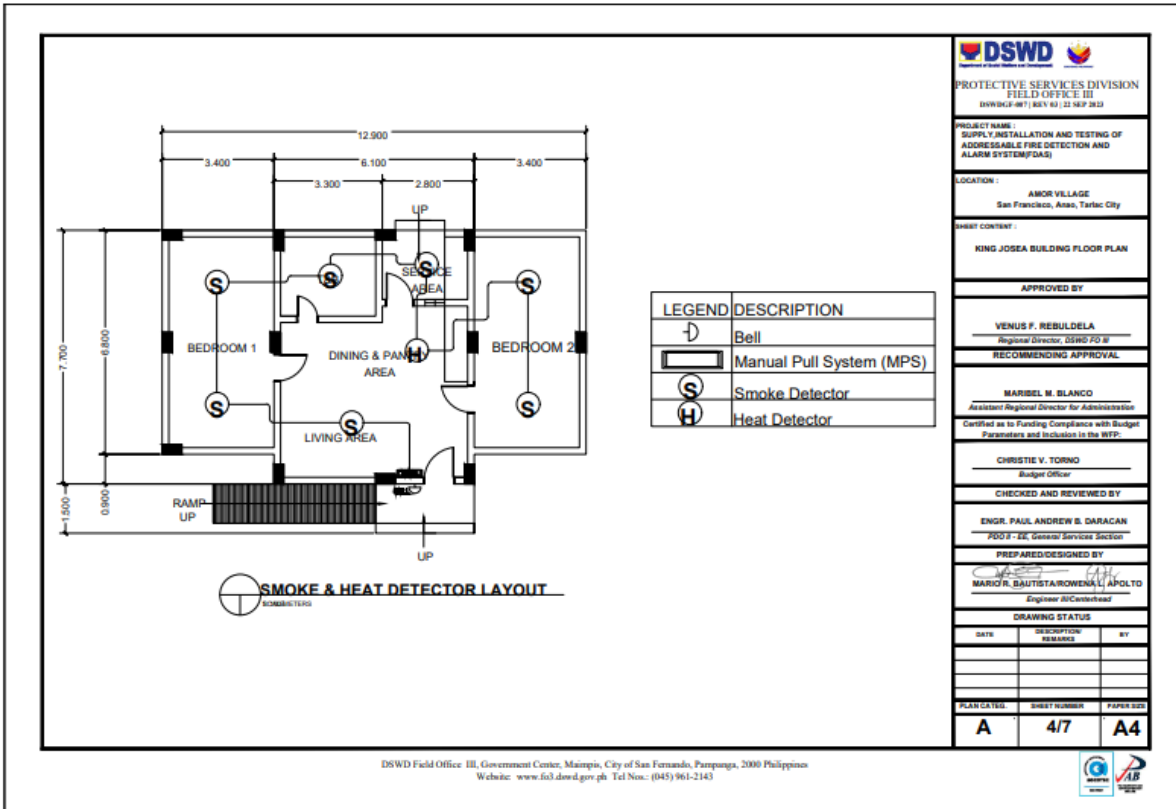

DSWD Field Office III, Government Center, Marikina, City of San Fernando, Pasig, 2000 Philippines  
Website: www.fid.dswd.gov.ph Tel No.: (045)961-2143

**DSWD**  
DEPARTMENT OF SOCIAL WELFARE AND HUMAN DEVELOPMENT

**PROTECTIVE SERVICES DIVISION**  
FIELD OFFICE III  
DSWB-CF-WF (REV 4), 22 SEP 2013

PROJECT NAME:  
SUPPLY, INSTALLATION AND TESTING OF ADDRESSABLE FIRE DETECTION AND ALARM SYSTEM (DAS)

LOCATION:  
AMOR VILLAGE  
San Francisco, Anaa, Tarlac City

SHEET CONTENT:  
KING JOSEFA BUILDING FLOOR PLAN

APPROVED BY:  
VENUS F. REBULDELA  
Regional Director, DSWD FO III  
RECOMMENDING APPROVAL

MARIEL M. BLANCO  
Assistant Regional Director for Administration  
Certified as to Funding Compliance with Budget Parameters and Inclusion in the WFP.

CHRISTIE V. TORNO  
Budget Officer

CHECKED AND REVIEWED BY:  
ENGR. PAUL ANDREW B. DARACAN  
2007-EE, General Services Section

PREPARED/DESIGNED BY:  
MARGOL BAUTISTA-ROVENA L. APOLTO  
Engineer/IC/Contractor

DRAWING STATUS

DATE	DESCRIPTION	BY

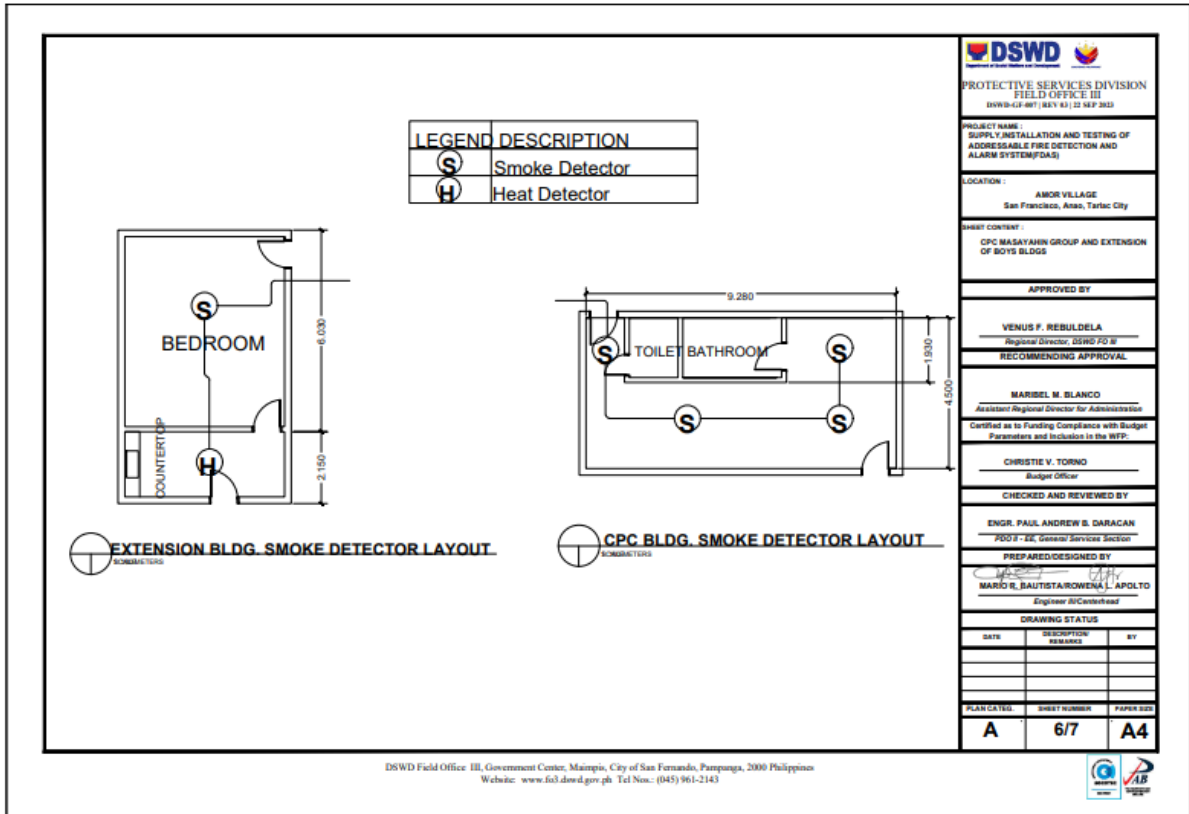
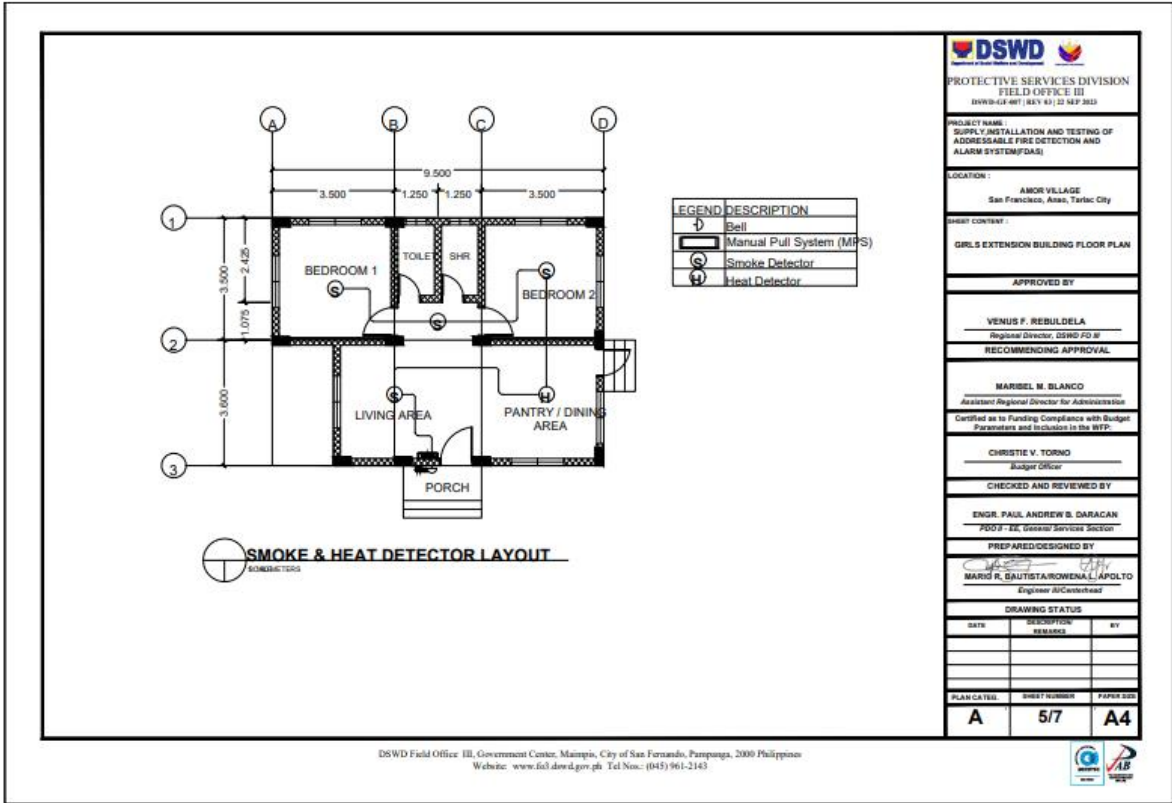

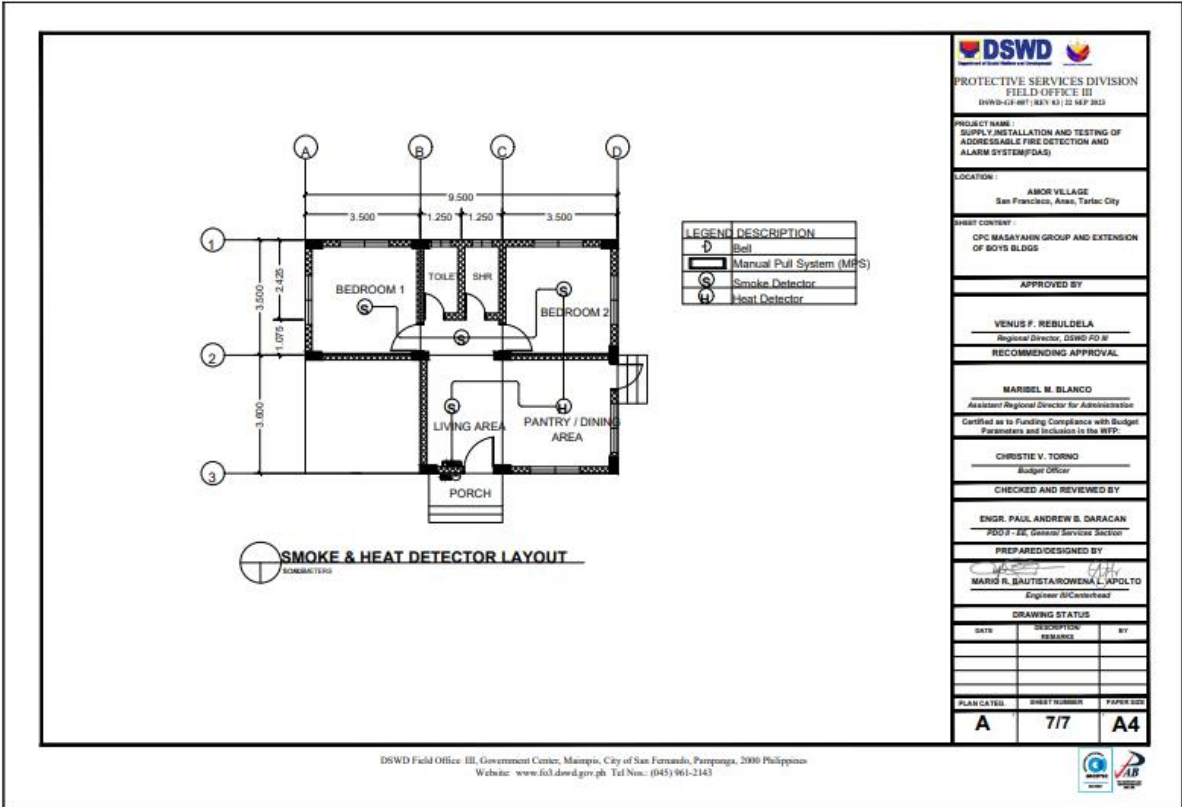



## ***Section VIII. Bill of Quantities***

### **Notes on the Bill of Quantities**

#### **Objectives**

The objectives of the Bill of Quantities are:

- a. to provide sufficient information on the quantities of Works to be performed to enable Bids to be prepared efficiently and accurately; and
- b. when a Contract has been entered into, to provide a priced Bill of Quantities for use in the periodic valuation of Works executed.

In order to attain these objectives, Works should be itemized in the Bill of Quantities in sufficient detail to distinguish between the different classes of Works, or between Works of the same nature carried out in different locations or in other circumstances which may give rise to different considerations of cost. Consistent with these requirements, the layout and content of the Bill of Quantities should be as simple and brief as possible.

#### **Daywork Schedule**

A Daywork Schedule should be included only if the probability of unforeseen work, outside the items included in the Bill of Quantities, is high. To facilitate checking by the Entity of the realism of rates quoted by the Bidders, the Daywork Schedule should normally comprise the following:

- a. A list of the various classes of labor, materials, and Constructional Plant for which basic daywork rates or prices are to be inserted by the Bidder, together with a statement of the conditions under which the Contractor will be paid for work executed on a daywork basis.
- b. Nominal quantities for each item of Daywork, to be priced by each Bidder at Daywork rates as Bid. The rate to be entered by the Bidder against each basic Daywork item should include the Contractor's profit, overheads, supervision, and other charges.

#### **Provisional Sums**

A general provision for physical contingencies (quantity overruns) may be made by including a provisional sum in the Summary Bill of Quantities. Similarly, a contingency allowance for possible price increases should be provided as a provisional sum in the Summary Bill of Quantities. The inclusion of such provisional sums often facilitates budgetary approval by avoiding the need to request periodic supplementary approvals as the future need arises. Where such provisional sums or contingency allowances are used, the SCC should state the manner in which they will be used, and under whose authority (usually the Procuring Entity's Representative's).

The estimated cost of specialized work to be carried out, or of special goods to be supplied, by other contractors should be indicated in the relevant part of the Bill of Quantities as a particular provisional sum with an appropriate brief description. A separate procurement procedure is normally carried out by the Procuring Entity to select such specialized contractors. To provide an element of competition among the Bidders in respect of any facilities, amenities, attendance, etc., to be provided by the successful Bidder as prime Contractor for the use and

convenience of the specialist contractors, each related provisional sum should be followed by an item in the Bill of Quantities inviting the Bidder to quote a sum for such amenities, facilities, attendance, etc.

**Signature Box**

A signature box shall be added at the bottom of each page of the Bill of Quantities where the authorized representative of the Bidder shall affix his signature. Failure of the authorized representative to sign each and every page of the Bill of Quantities shall be a cause for rejection of his bid.

These Notes for Preparing a Bill of Quantities are intended only as information for the Procuring Entity or the person drafting the Bidding Documents. They should not be included in the final documents.

## BILL OF QUANTITIES

Name of Project:	<b>SUPPLY, INSTALLATION AND TESTING OF ADDRESSABLE FIRE DETECTION AND ALARM SYSTEM(FDAS)</b>	Location:	<b>AMOR VILLAGE, SAN FRANCISCO EAST, ANAO, TARLAC CITY</b>
Total Project Cost:	<b>PHP -</b>	Project Duration:	<b>35 Calendar Days</b>
Date:	<b>Wednesday, January 10, 2024</b>	Mode of Procurement:	<b>Competitive Bidding</b>
		Source of Manpower:	<b>Outsource</b>

I GENERAL REQUIREMENTS							
Item No.	Item Description	Quantity	Unit	Material Cost	Labor /Equipment Cost	Unit Cost	Amount
1	Mobilization/Demobilization	1.00	lot			-	-
2	Temporary Facilities	1.00	lot			-	-
3	As-Built Plans duly signed and sealed by Professional Electrical Engineer	1.00	lot			-	-
<b>SUB - TOTAL (GENERAL REQUIREMENTS)</b>							<b>-</b>

II CONSTRUCTION WORKS							
Item No.	Item Description	Quantity	Unit	Material Cost	Labor /Equipment Cost	Unit Cost	Amount
<b>Electrical and Mechanical Works</b>							
1.00							
	1.10 TF Wire # 16	28.00	rolls			-	-
	1.20 THHN Wire # 16	1.00	rolls			-	-
	1.30 Flexible Hose Metal 1/2"	5.00	roll			-	-
	1.40 EMT Conduit Pipe 1/2"	250.00	pcs.			-	-
	1.50 EMT Male Connector 1/2"	700.00	pcs.			-	-
	1.60 Junction Box, Metal, 2"x2"	200.00	pcs.			-	-
	1.70 Square Box, Metal, 4"x4"	7.00	pcs.			-	-
	1.80 U-Clamp, Metal, 2-holes, 1/2"	100.00	pcs.			-	-
	1.90 Electrical Tape	5.00	rolls			-	-
	1.2.1 Tox and Screw 1-1/2"	400.00	pcs.			-	-
	1.2.2 Metal Screw Black 1-1/2"	800.00	pcs.			-	-
	1.2.3 Cable Tie 6"	1.00	pack			-	-
	1.2.4 Cable Tie Tagging	1.00	lot			-	-
	1.2.5 Coupling Connector 1/2"	80.00	pcs.			-	-
	1.2.6 Miscellaneous and Consumables	1.00	lot			-	-
	1.2.7 Fire Alarm Control Panel, Addressable, 2-Loop	1.00	pcs.			-	-
	1.2.8 Batteries, Addressable	2.00	pcs.			-	-
	1.2.9 Smoke Detector, Addressable	81.00	pcs.			-	-
	1.3.1 Heat Detector, Addressable	4.00	pcs.			-	-
	1.3.2 Manual Call Point, Addressable with Bell	8.00	sets			-	-
	1.3.3 Horn Strobe, Addressable	6.00	pcs.			-	-
	1.3.4 Anunciator, Addressable	1.00	pcs.			-	-
<b>SUB - TOTAL (Electrical and Mechanical Works)</b>							<b>-</b>
A	Total Direct Cost (Material, Labor and Equipment )						<b>-</b>
B	Overhead, Contingencies and Miscellaneous (OCM) ( % of A )						<b>-</b>
C	Contractor's Profit (CP) ( % of A )						<b>-</b>
D	Value Added Tax ( VAT) ( % of A+B+C )						<b>-</b>
E	Mobilization/Demobilization						<b>-</b>
<b>TOTAL PROJECT COST</b>						<b>PHP</b>	<b>-</b>

## **Detailed Unit Price Analysis (DUPA)**

Please download the abovementioned forms via link:

**<https://tinyurl.com/FDASAmor>**

**or**

**[https://drive.google.com/drive/u/3/folders/1N7iUs8VJXxxcUn4ukxU42dMOx12t5OW\\_](https://drive.google.com/drive/u/3/folders/1N7iUs8VJXxxcUn4ukxU42dMOx12t5OW_)**

## ***Section IX. Checklist of Technical and Financial Documents***

### **Notes on the Checklist of Technical and Financial Documents**

The prescribed documents in the checklist are mandatory to be submitted in the Bid, but shall be subject to the following:

- a. GPPB Resolution No. 09-2020 on the efficient procurement measures during a State of Calamity or other similar issuances that shall allow the use of alternate documents in lieu of the mandated requirements; or
- b. any subsequent GPPB issuances adjusting the documentary requirements after the effectivity of the adoption of the PBDs.

The BAC shall be checking the submitted documents of each Bidder against this checklist to ascertain if they are all present, using a non-discretionary “pass/fail” criterion pursuant to Section 30 of the 2016 revised IRR of RA No. 9184.

# Checklist of Technical and Financial Documents

## I. TECHNICAL COMPONENT ENVELOPE

### *Class "A" Documents*

#### Legal Documents

- (a) Valid PhilGEPS Registration Certificate (Platinum Membership) (all pages) in accordance with Section 8.5.2 of the IRR;

#### Technical Documents

- (b) Statement of the prospective bidder of all its ongoing government and private contracts, including contracts awarded but not yet started, if any, whether similar or not similar in nature and complexity to the contract to be bid; **and**
- (c) Statement of the bidder's Single Largest Completed Contract (SLCC) similar to the contract to be bid, except under conditions provided under the rules; **and**
- (d) Special PCAB License in case of Joint Ventures **and** registration for the type and cost of the contract to be bid; **and**
- (e) Original copy of Bid Security. If in the form of a Surety Bond, submit also a certification issued by the Insurance Commission **or** original copy of Notarized Bid Securing Declaration; **and**
- (f) Project Requirements, which shall include the following:
- a. Organizational chart for the contract to be bid;
- b. List of contractor's key personnel (*e.g.*, Project Manager, Project Engineers, Materials Engineers, and Foremen), to be assigned to the contract to be bid, with their complete qualification and experience data;
- c. List of contractor's major equipment units, which are owned, leased, and/or under purchase agreements, supported by proof of ownership or certification of availability of equipment from the equipment lessor/vendor for the duration of the project, as the case may be; **and**
- (g) Original duly signed Omnibus Sworn Statement (OSS) **and** if applicable, Original Notarized Secretary's Certificate in case of a corporation, partnership, or cooperative; or Original Special Power of Attorney of all members of the joint venture giving full power and authority to its officer to sign the OSS and do acts to represent the Bidder.

#### Financial Documents

- (h) The prospective bidder's computation of Net Financial Contracting Capacity (NFCC).

***Class “B” Documents***

- (i) If applicable, duly signed joint venture agreement (JVA) in accordance with RA No. 4566 and its IRR in case the joint venture is already in existence **or** duly notarized statements from all the potential joint venture partners stating that they will enter into and abide by the provisions of the JVA in the instance that the bid is successful.

**II. FINANCIAL COMPONENT ENVELOPE**

- (j) Original of duly signed and accomplished Financial Bid Form; **and**

*Other documentary requirements under RA No. 9184*

- (k) Original of duly signed Bid Prices in the Bill of Quantities; **and**
- (l) Duly accomplished Detailed Estimates Form, including a summary sheet indicating the unit prices of construction materials, labor rates, and equipment rentals used in coming up with the Bid; **and**
- (m) Cash Flow by Quarter.

## ***Section IX. Bidding Forms***



# **OMNIBUS SWORN STATEMENT**

## Omnibus Sworn Statement (Revised)

*[shall be submitted with the Bid]*

---

REPUBLIC OF THE PHILIPPINES )  
CITY/MUNICIPALITY OF \_\_\_\_\_ )  
S.S.

### AFFIDAVIT

I, [Name of Affiant], of legal age, [Civil Status], [Nationality], and residing at [Address of Affiant], after having been duly sworn in accordance with law, do hereby depose and state that:

1. *[Select one, delete the other:]*

*[If a sole proprietorship:]* I am the sole proprietor or authorized representative of [Name of Bidder] with office address at [address of Bidder];

*[If a partnership, corporation, cooperative, or joint venture:]* I am the duly authorized and designated representative of [Name of Bidder] with office address at [address of Bidder];

2. *[Select one, delete the other:]*

*[If a sole proprietorship:]* As the owner and sole proprietor, or authorized representative of [Name of Bidder], I have full power and authority to do, execute and perform any and all acts necessary to participate, submit the bid, and to sign and execute the ensuing contract for [Name of the Project] of the [Name of the Procuring Entity], as shown in the attached duly notarized Special Power of Attorney;

*[If a partnership, corporation, cooperative, or joint venture:]* I am granted full power and authority to do, execute and perform any and all acts necessary to participate, submit the bid, and to sign and execute the ensuing contract for [Name of the Project] of the [Name of the Procuring Entity], as shown in the attached [state title of attached document showing proof of authorization (e.g., duly notarized Secretary's Certificate, Board/Partnership Resolution, or Special Power of Attorney, whichever is applicable)];

3. [Name of Bidder] is not "blacklisted" or barred from bidding by the Government of the Philippines or any of its agencies, offices, corporations, or Local Government Units, foreign government/foreign or international financing institution whose blacklisting rules have been recognized by the Government Procurement Policy Board, **by itself or by relation, membership, association, affiliation, or controlling interest with another blacklisted person or entity as defined and provided for in the Uniform Guidelines on Blacklisting;**

4. Each of the documents submitted in satisfaction of the bidding requirements is an authentic copy of the original, complete, and all statements and information provided therein are true and correct;

5. [Name of Bidder] is authorizing the Head of the Procuring Entity or its duly authorized representative(s) to verify all the documents submitted;

6. *[Select one, delete the rest:]*

*[If a sole proprietorship:]* The owner or sole proprietor is not related to the Head of the Procuring Entity, members of the Bids and Awards Committee (BAC), the Technical Working Group, and the BAC

Secretariat, the head of the Project Management Office or the end-user unit, and the project consultants by consanguinity or affinity up to the third civil degree;

7. *[Name of Bidder]* complies with existing labor laws and standards; and

8. *[Name of Bidder]* is aware of and has undertaken the responsibilities as a Bidder in compliance with the Philippine Bidding Documents, which includes:

- a. Carefully examining all of the Bidding Documents;
- b. Acknowledging all conditions, local or otherwise, affecting the implementation of the Contract;
- c. Making an estimate of the facilities available and needed for the contract to be bid, if any; and
- d. Inquiring or securing Supplemental/Bid Bulletin(s) issued for the *[Name of the Project]*.

9. *[Name of Bidder]* did not give or pay directly or indirectly, any commission, amount, fee, or any form of consideration, pecuniary or otherwise, to any person or official, personnel or representative of the government in relation to any procurement project or activity.

**10. In case advance payment was made or given, failure to perform or deliver any of the obligations and undertakings in the contract shall be sufficient grounds to constitute criminal liability for Swindling (Estafa) or the commission of fraud with unfaithfulness or abuse of confidence through misappropriating or converting any payment received by a person or entity under an obligation involving the duty to deliver certain goods or services, to the prejudice of the public and the government of the Philippines pursuant to Article 315 of Act No. 3815 s. 1930, as amended, or the Revised Penal Code.**

IN WITNESS WHEREOF, I have hereunto set my hand this \_\_\_\_\_ day \_\_\_\_\_ of \_\_\_\_\_, 20\_\_\_\_ at \_\_\_\_\_, Philippines.

---

*[Insert NAME OF BIDDER OR ITS AUTHORIZED REPRESENTATIVE]*

*[Insert signatory's legal capacity]*

Affiant

**[Jurat]**

*[Format shall be based on the latest Rules on Notarial Practice]*

**NET FINANCIAL CONTRACTING CAPACITY**

**Bidder's Company Letterhead)**

1. The detailed computation must be shown using the formula provided above.
2. The NFCC computation must be at least equal to the ABC of the project

[TITLE OF THE PROJECT]

**Approved Budget for the Contract (ABC): Php Approved Budget for the Contract**

**CERTIFICATE OF NET FINANCIAL CONTRACTING CAPACITY (NFCC)**

(Please show figures at how you arrived at the NFCC)

This is to certify that our Net Financial Contracting Capacity (NFCC) is \_\_\_\_ (Php\_\_\_\_) which is at least equal to the total ceiling price we are bidding. The amount is computed as follows:

<b>CA</b>		<b>Current Assets</b>	<b>₱</b>
<b>Less:</b>			-
<b>CL</b>		<b>Current Liabilities</b>	<b>₱</b>
<b>Sub-Total 1</b>			<b>₱</b>
			<b>X 15</b>
<b>Sub-Total 2</b>			<b>₱</b>
<b>Less:</b>			-
<b>C</b>		Value of all outstanding or uncompleted portions of the projects under on-going contracts, including awarded contracts yet to be started coinciding with the contract for this Project	<b>₱</b>
<b>NFCC</b>			<b>₱</b>

Issued this \_\_\_\_\_ day of \_\_\_\_\_, 2023.

\_\_\_\_\_  
Name of Company

\_\_\_\_\_  
Signature of Bidder or Authorized Representative

\_\_\_\_\_  
Name and Designation

\*\*\* This document must be attached to the Technical Component Envelope \*\*\*

3. The phrase “value of the bidder’s current assets and current liabilities” shall be based on the data submitted to the BIR, which refers to the values of the current assets and current liabilities reflected in the Audited Financial Statements.
4. The value of all outstanding or uncompleted contracts refers to those listed in Annex II.

# **BID FORM**

# Bid Form for the Procurement of Infrastructure Projects

*[shall be submitted with the Bid]*

---

## BID FORM

Date : \_\_\_\_\_

Project Identification No. : \_\_\_\_\_

To: *[Name and address of Procuring Entity]*

Having examined the Philippine Bidding Documents (PBDs) including the Supplemental or Bid Bulletin Numbers *[insert numbers]*, the receipt of which is hereby duly acknowledged, we, the undersigned, declare that:

- a. We have no reservation to the PBDs, including the Supplemental or Bid Bulletins, for the Procurement Project: *[insert name of contract]*;
- b. We offer to execute the Works for this Contract in accordance with the PBDs;
- c. The total price of our Bid in words and figures, excluding any discounts offered below is:  
*[insert information]*;
- d. The discounts offered and the methodology for their application are: *[insert information]*;
- e. The total bid price includes the cost of all taxes, such as, but not limited to: *[specify the applicable taxes, e.g. (i) value added tax (VAT), (ii) income tax, (iii) local taxes, and (iv) other fiscal levies and duties]*, which are itemized herein and reflected in the detailed estimates,
- f. Our Bid shall be valid within the a period stated in the PBDs, and it shall remain binding upon us at any time before the expiration of that period;
- g. If our Bid is accepted, we commit to obtain a Performance Security in the amount of *[insert percentage amount]* percent of the Contract Price for the due performance of the Contract, or a Performance Securing Declaration in lieu of the the allowable forms of Performance Security, subject to the terms and conditions of issued GPPB guidelines<sup>2</sup> for this purpose;
- h. We are not participating, as Bidders, in more than one Bid in this bidding process, other than alternative offers in accordance with the Bidding Documents;



- i. We understand that this Bid, together with your written acceptance thereof included in your notification of award, shall constitute a binding contract between us, until a formal Contract is prepared and executed; and
- j. We understand that you are not bound to accept the Lowest Calculated Bid or any other Bid that you may receive.

---

2 currently based on GPPB Resolution No. 09-2020

k. We likewise certify/confirm that the undersigned, is the duly authorized representative of the bidder, and granted full power and authority to do, execute and perform any and all acts necessary to participate, submit the bid, and to sign and execute the ensuing contract for the [Name of Project] of the [Name of the Procuring Entity].

l. We acknowledge that failure to sign each and every page of this Bid Form, including the Bill of Quantities, shall be a ground for the rejection of our bid.

Name: \_\_\_\_\_  
Legal Capacity: \_\_\_\_\_  
Signature: \_\_\_\_\_  
Duly authorized to sign the Bid for and behalf of: \_\_\_\_\_  
Date: \_\_\_\_\_

# Contract Agreement Form for the Procurement of Infrastructure Projects (Revised)

*[not required to be submitted with the Bid, but it shall be submitted within ten (10) days after receiving the Notice of Award]*

---

## CONTRACT AGREEMENT

THIS AGREEMENT, made this *[insert date]* day of *[insert month]*, *[insert year]* between *[name and address of PROCURING ENTITY]* (hereinafter called the "Entity") and *[name and address of Contractor]* (hereinafter called the "Contractor").

WHEREAS, the Entity is desirous that the Contractor execute *[name and identification number of contract]* (hereinafter called "the Works") and the Entity has accepted the Bid for *[contract price in words and figures in specified currency]* by the Contractor for the execution and completion of such Works and the remedying of any defects therein.

NOW THIS AGREEMENT WITNESSETH AS FOLLOWS:

1. In this Agreement, words and expressions shall have the same meanings as are respectively assigned to them in the Conditions of Contract hereinafter referred to.
2. The following documents as required by the 2016 revised Implementing Rules and Regulations of Republic Act No. 9184 shall be deemed to form and be read and construed as part of this Agreement, *viz.*:
  - a. Philippine Bidding Documents (PBDs);
    - i. Drawings/Plans;
    - ii. Specifications;
    - iii. Bill of Quantities;
    - iv. General and Special Conditions of Contract;
    - v. Supplemental or Bid Bulletins, if any;
  - b. Winning bidder's bid, including the Eligibility requirements, Technical and Financial Proposals, and all other documents or statements submitted;

Bid form, including all the documents/statements contained in the Bidder's bidding envelopes, as annexes, and all other documents submitted (*e.g.*, Bidder's response to request for clarifications on the bid), including corrections to the bid, if any, resulting from the Procuring Entity's bid evaluation;

- c. Performance Security;
  - d. Notice of Award of Contract and the Bidder's conforme thereto; and
  - e. Other contract documents that may be required by existing laws and/or the Procuring Entity concerned in the PBDs. **Winning bidder agrees that additional contract documents or information prescribed by the GPPB that are subsequently required for submission after the contract execution, such as the Notice to Proceed, Variation Orders, and Warranty Security, shall likewise form part of the Contract.**
3. In consideration for the sum of *[total contract price in words and figures]* or such other sums as may be ascertained, *[Named of the bidder]* agrees to *[state the object of the contract]* in accordance with his/her/its Bid.
  4. The *[Name of the procuring entity]* agrees to pay the above-mentioned sum in accordance with the terms of the Bidding.

IN WITNESS whereof the parties thereto have caused this Agreement to be executed the day and year first before written.

*[Insert Name and Signature]*

*[Insert Name and Signature]*

*[Insert Signatory's Legal Capacity]*

*[Insert Signatory's Legal Capacity]*

*for:*

*for:*

*[Insert Procuring Entity]*

*[Insert Name of Supplier]*

**Acknowledgment**

*[Format shall be based on the latest Rules on Notarial Practice]*

**STATEMENT OF ALL ONGOING  
GOVERNMENT AND PRIVATE CONTRACTS**

**Statement of All On-Going Government and Private Contracts, Including  
Contracts Awarded but Not Yet Started, Whether Similar or Not Similar**

---

**in Nature and Complexity to the Contract to be Bid**

Business Name:

Business Address:

A. Government

Nature of Contract (Project Title)	a. Owner's Name	Project Cost	Bidder's Role		a. Date Awarded	% of Accomplishment		Value of Outstanding Works (Undelivered Portion)
	b. Address		Description	%	b. Date Started	Planned	Actual	
	c. Contact Nos.				c. Target Date of Completion			
1.	a.				a.			
	b.				b.			
	c.				c.			
2.	a.				a.			
	b.				b.			
	c.				c.			

B. Private

Nature of Contract (Project Title)	a. Owner's Name	Project Cost	Bidder's Role		a. Date Awarded	% of Accomplishment		Value of Outstanding Works (Undelivered Portion)
	b. Address		Description	%	b. Date Started	Planned	Actual	
	c. Contact Nos.				c. Target Date of Completion			
1.	a.				a.			
	b.				b.			
	c.				c.			
2.	a.				a.			
	b.				b.			
	c.				c.			

*Note: The following documents must be attached to support this statement: and its original copy of documents must be available upon request of the Bids and Award Committee (BAC) or designated Technical Working Group (TWG) during Post-Qualification:*

**(a) Notice of Award, (b) Contract or Purchase Order (c) Notice to Proceed**

*as may be applicable.*

Name: \_\_\_\_\_

Legal Capacity: \_\_\_\_\_

Signature: \_\_\_\_\_

Duly authorized to sign the Bid for and behalf of: \_\_\_\_\_

**STATEMENT OF SINGLE LARGEST  
COMPLETED CONTRACT**

**Statement of Single Largest Completed Contract (SLCC)  
Similar to the Contract to be Bid**

---

Business Name: \_\_\_\_\_

Business Address: \_\_\_\_\_

Nature of Contract (Project Title)	a. Owner's Name	Project Cost	Bidder's Role		a. Date Awarded
	b. Address		Description	%	b. Date Started
	c. Contact Nos.				c. Date Completed
	a.				a.
	b.				b.
	c.				c.

*Note: The following documents must be attached to support this statement:*

- (a) Official Receipt(s) or Sales Invoice;
- (b) User's Certificate of Completion and/ or at least Satisfactory CPES Rating or any duly issued certificate showing the performance of the Contractor; and
- (c) Certificate of Final Acceptance

Name: \_\_\_\_\_

Legal Capacity: \_\_\_\_\_

Signature: \_\_\_\_\_

Duly authorized to sign the Bid for and behalf of: \_\_\_\_\_

<sup>1</sup> The Bidder must have completed, within the period specified in the Invitation to Bid and ITB Clause 5.2 of Section III. Bid Data Sheet, a single contract that is similar to the project to be bid, equivalent to a percentage (%) of the ABC specified in ITB Clause

5.2 of Section II. Instruction to Bidders.



# **MANPOWER UTILIZATION SCHEDULE**

Name of the Procuring Entity  
 Contract Reference Number  
 Name of the Contract  
 Location of the Contract

**MANPOWER UTILIZATION SCHEDULE**

Category	Month											
Contractor's Name:	Name of the Procuring Entity:					Contract Name:						

Submitted by:

Name of the Representative of the Bidder

Date: \_\_\_\_\_

Position

Name of the Bidder

The manpower schedule (weekly or monthly scheduling of skilled and unskilled workers, including Project Manager, Project Engineers, Materials Engineers, or Foremen) is required to be in the Technical Envelope of the Bidder.

## Qualification of Key Personnel Proposed to be Assigned to the Contract

**Business Name** : \_\_\_\_\_

**Business Address** : \_\_\_\_\_

<b>1</b>	<b>Name</b>				
<b>2</b>	<b>Address</b>				
<b>3</b>	<b>Date of Birth</b>				
<b>4</b>	<b>Employed since</b>				
<b>5</b>	<b>Experience</b>				
<b>6</b>	<b>Previous</b>				
<b>7</b>	<b>Education</b>				
<b>8</b>	<b>PRC License</b>				

**Minimum**

- One (1) Project Manager (Either a Licensed Civil Engineer with at least 3 years of relevant experience or a Licensed Architect with at least three (3) years of relevant experience and license Electrical Engineer with at least 3 years of relevant experience)
- One (1) General Foreman with at least three (3) years of relevant experience

**Note** : Attached individual resume and PRC License of the (professional) personnel.

**Submitted by** : \_\_\_\_\_

(Printed Name & Signature)

**Designation** : \_\_\_\_\_

**Date** : \_\_\_\_\_

*One of the requirements from the bidder to be included in its Technical Envelope is a list of contractor's key personnel (viz., Project Manager, Project Engineers, Materials Engineers, and Foremen), to be assigned to the contract to be bid, with their complete qualification and experience data (including the key personnel's signed written commitment to work for the project once awarded the contract).*

Name of the Procuring Entity  
 Contract Reference Number  
 Name of the Contract  
 Location of the Contract

*List of Equipment, Owned or Leased and/or under Purchase Agreements, Pledged to  
 the Proposed Contract*

**Business Name** : \_\_\_\_\_

**Business Address** : \_\_\_\_\_

Description	Model/Year	Capacity / Performance / Size	Plate No.	Motor No. /Body No.	Location	Condition	Proof of Ownership / Lessor or Vendor
<b>A. Owned</b>							
i.							
ii.							
iii.							
iv.							
v.							
<b>B. Leased</b>							
i.							
ii.							
iv.							
v.							
<b>C. Under Purchase Agreements</b>							
i.							
ii.							
iii.							
iv.							
v.							

List of minimum equipment required for the project:

**Submitted by** : \_\_\_\_\_  
(Printed Name & Signature)

**Designation** : \_\_\_\_\_

**Date** : \_\_\_\_\_

*One of the requirements from the bidder to be included in its Technical Envelope is the list of its equipment units pledged for the contract to be bid, which are owned (supported by proof/s of ownership), leased, and/or under purchase agreements (with corresponding engine numbers, chassis numbers and/or serial numbers), supported by certification of availability of equipment from the equipment lessor/vendor for the duration of the project.*

Name of the Procuring Entity  
Contract Reference Number  
Name of the Contract  
Location of the Contract

## Statement of Availability of Key Personnel and Equipment

(Date of Issuance)

Name of the Head of the Procuring Entity  
Position of the Head of the Procuring Entity  
(Name of Procuring Entity)

(Address of Procuring Entity)

Attention : The Chairman  
Bids and Awards Committee

Dear Sir / Madame:

In compliance with the requirements of the (Name of the Procuring Entity) BAC for the bidding of the (Name of the Contract) , we certify that (Name of the Bidder) has in its employ key personnel, such as project managers, project engineers, materials engineers and foremen, who may be engaged for the construction of the said contract.

Further, we likewise certify the availability of equipment that (Name of the Bidder) owns, has under lease, and/or has under purchase agreements, that may be used for the construction contracts.

Very truly yours,

(Name of Representative)  
(Position)  
(Name of Bidder)

# Key Personnel's Certificate of Employment

## Issuance Date

Name of the Head of the Procuring Entity

Position of the Head of the Procuring Entity

Name of the Procuring Entity

Address of the Procuring Entity

Dear Sir / Madame:

I am (Name of Nominee) a Licensed Engineer with Professional License No. issued on \_\_\_\_\_  
(date of issuance) at (place of issuance) .

I hereby certify that (Name of Bidder) has engaged my services as (Designation) for (Name of the Contract), if awarded to it.

As (Designation) , I supervised the following completed projects similar to the contract under bidding):

<u>NAME OF PROJECT</u>	<u>OWNER</u>	<u>COST</u>	<u>DATE COMPLETED</u>
------------------------	--------------	-------------	-----------------------

At present, I am supervising the following projects:

<u>NAME OF PROJECT</u>	<u>OWNER</u>	<u>COST</u>	<u>DATE COMPLETED</u>
------------------------	--------------	-------------	-----------------------

In case of my separation for any reason whatsoever from the above-mentioned Contractor, I shall notify the

(Name of the Procuring Entity) at least twenty one (21) days before the effective date of my separation.

As (Designation), I know I will have to stay in the job site all the time to supervise and manage the Contractworks to the best of my ability, and aware that I am authorized to handle only one (1) contract at a time.

I do not allow the use of my name for the purpose of enabling the above-mentioned Contractor to qualify for the Contract without any firm commitment on my part to assume the post of

(Designation)

)

\_\_\_\_\_therefor, if the contract is awarded to him since I understand that to do so will be a sufficient ground

for my disqualification as (Designation) in any future (Name of the Procuring Entity) bidding or employment with any Contractor doing business with the

(Name of the Procuring Entity).

(Signature of Engineer)

Name of the Procuring Entity  
Contract Reference Number  
Name of the Contract  
Location of the Contract

**DRY SEAL**

Republic of the Philippines )  
\_\_\_\_\_ ) S.S.

SUBSCRIBED AND SWORN TO before me this \_\_\_\_\_ day of \_\_\_\_\_ 2003 affiant exhibiting to me his Residence Certificate No. \_\_\_\_\_ issued on \_\_\_\_\_ at \_\_\_\_\_  
\_\_\_\_\_.

Notary Public  
Until December 31, 20\_\_

Doc. No. \_\_\_\_\_;  
Page No. \_\_\_\_\_;  
Book No. \_\_\_\_\_;  
Series of \_\_\_\_\_;



Key Personnel to be assigned to the contract to be bid, with their complete qualification and experience data (including the key personnel's signed written commitment to work for the project once awarded the contract).

Name of the Procuring Entity  
 Contract Reference Number  
 Name of the Contract  
 Location of the Contract

**KEY PERSONNEL (FORMAT OF BIO-DATA)**

Give the detailed information of the following personnel who are scheduled to be assigned as full-time field staff for the project. Fill up a form for each person.

- Authorized Managing Officer / Representative
- Sustained Technical Employee

1. Name : \_\_\_\_\_
2. Date of Birth : \_\_\_\_\_
3. Nationality : \_\_\_\_\_
4. Education and Degrees : \_\_\_\_\_
5. Specialty : \_\_\_\_\_
6. Registration : \_\_\_\_\_
7. Length of Service with the Firm : \_\_\_\_\_ Year from \_\_\_\_\_(months)\_\_\_\_\_(year)  
 To \_\_\_\_\_(months)\_\_\_\_\_(year)
8. Years of Experience : \_\_\_\_\_
9. If Item 7 is less than ten (10) years, give name and length of service with previous employers for a ten (10)-year period (attached additional sheet/s), if necessary:

Name and Address of Employer

Length of Service

\_\_\_\_\_  
 \_\_\_\_\_  
 \_\_\_\_\_

\_\_\_\_\_ year(s) from \_\_\_\_\_ to \_\_\_\_\_  
 \_\_\_\_\_ year(s) from \_\_\_\_\_ to \_\_\_\_\_  
 \_\_\_\_\_ year(s) from \_\_\_\_\_ to \_\_\_\_\_

10. Experience:

This should cover the past ten (10) years of experience. (Attached as many pages as necessary to show involvement of personnel in projects using the format below).

---

Name and Signature of Employee

It is hereby certified that the above personnel can be assigned to this project, if the contract is awarded to our company.

---

(Place and Date)

---

(The Authorized Representative)

## **Contractor's Organizational Chart for the Contract**

Submit Copy of the Organizational Chart that the Contractor intends to use to execute the Contract if awarded to him. Indicate in the chart the names of the Project Manager, Project Engineer, Bridge Engineer, Structural Engineer, Materials and Quality Control Engineer, Foreman and other Key Engineering Personnel.

Attach the required Proposed Organizational Chart for the Contract as stated above

- 1. This organization chart should represent the "Contractor's Organization" required for the Project, and not the organizational chart of the entire firm.*
- 2. All these are required to be in the Technical Envelope of the Bidder.*

## **Bid Securing Declaration Form**

*[shall be submitted with the Bid if bidder opts to provide this form of bid security]*

---

REPUBLIC OF THE PHILIPPINES)  
CITY OF \_\_\_\_\_) S.S.

### **BID SECURING DECLARATION**

**Project Identification No.: *[Insert number]***

To: *[Insert name and address of the Procuring Entity]*

I/We, the undersigned, declare that:

1. I/We understand that, according to your conditions, bids must be supported by a Bid Security, which may be in the form of a Bid Securing Declaration.
2. I/We accept that: (a) I/we will be automatically disqualified from bidding for any procurement contract with any procuring entity for a period of two (2) years upon receipt of your Blacklisting Order; and, (b) I/we will pay the applicable fine provided under Section 6 of the Guidelines on the Use of Bid Securing Declaration, within fifteen (15) days from receipt of the written demand by the procuring entity for the commission of acts resulting to the enforcement of the bid securing declaration under Sections 23.1(b), 34.2, 40.1 and 69.1, except 69.1(f), of the IRR of RA No. 9184; without prejudice to other legal action the government may undertake.
3. I/We understand that this Bid Securing Declaration shall cease to be valid on the following circumstances:
  - a. Upon expiration of the bid validity period, or any extension thereof pursuant to your request;
  - b. I am/we are declared ineligible or post-disqualified upon receipt of your notice to such effect, and
    - (i) I/we failed to timely file a request for reconsideration or (ii) I/we filed a waiver to avail of said right; and
  - c. I am/we are declared the bidder with the Lowest Calculated Responsive Bid, and I/we have furnished the performance security and signed the Contract.

IN WITNESS WHEREOF, I/We have hereunto set my/our hand/s this \_\_\_\_\_ day of *[month]* *[year]* at *[place of execution]*.

—  
*[Insert NAME OF BIDDER OR ITS AUTHORIZED REPRESENTATIVE]*

*[Insert signatory's legal capacity]*

Affiant

**Jurat**

[Format shall be based on the latest Rules on Notarial Practice]

Bidder's Company Letterhead

**[PROJECT TITLE]**

**Approved Budget for the Contract (ABC): [ABC here]**

**CERTIFICATE OF NET FINANCIAL CONTRACTING CAPACITY (NFCC)**

(Please show figures at how you arrived at the NFCC --- -----)

This is to certify that our **Net Financial Contracting Capacity (NFCC)** is

(Php \_\_\_\_\_) which is at least equal to the total ceiling price we are bidding. The amount is computed as follows:

<b>CA</b>	=	<b>Current Assets</b>	<b>₱</b>
<b>Less:</b>			-
<b>CL</b>	=	<b>Current Liabilities</b>	<b>₱</b>
<b>Sub-Total 1</b>			<b>₱</b>
			<b>X 15</b>
<b>Sub-Total 2</b>			<b>₱</b>
<b>Less:</b>			-
<b>C</b>	=	Value of all outstanding or uncompleted portions of the projects under on-going contracts, including awarded contracts yet to be started coinciding with the contract for this Project	<b>₱</b>
<b>NFCC</b>			<b>₱</b>

Issued this \_\_\_\_\_ day of \_\_\_\_\_, 2024.

\_\_\_\_\_  
Name of Company

\_\_\_\_\_  
Signature of Authorized Representative

\_\_\_\_\_  
Name and Designation

\*\*\* This document must be attached to the Technical Component Envelope \*\*\*

The phrase "value of the bidder's current assets and current liabilities" shall be based on the data submitted to the

1. BIR, which refers to the values of the current assets and current liabilities reflected in the Audited Financial Statements.
2. The value of all outstanding or uncompleted contracts refers to those listed in Annex II.
3. The detailed computation must be shown using the formula provided above.

4. The NFCC computation must be at least equal to the ABC of the project

## **Bid Form for the Procurement of Infrastructure Projects** [shall be submitted with the Bid]

---

### **BID FORM**

Date : \_\_\_\_\_

Project Identification No. : \_\_\_\_\_

To: *[Name and address of Procuring Entity]*

Having examined the Philippine Bidding Documents (PBDs) including the Supplemental or Bid Bulletin Numbers [insert numbers], the receipt of which is hereby duly acknowledged, we, the undersigned, declare that:

- a. We have no reservation to the PBDs, including the Supplemental or Bid Bulletins, for the Procurement Project: [insert name of contract];
- b. We offer to execute the Works for this Contract in accordance with the PBDs;
- c. The total price of our Bid in words and figures, excluding any discounts offered below is: [insert information];
- d. The discounts offered and the methodology for their application are: [insert information];
- e. The total bid price includes the cost of all taxes, such as, but not limited to: [specify the applicable taxes, e.g. (i) value added tax (VAT), (ii) income tax, (iii) local taxes, and (iv) other fiscal levies and duties], which are itemized herein and reflected in the detailed estimates,
- f. Our Bid shall be valid within the a period stated in the PBDs, and it shall remain binding upon us at any time before the expiration of that period;
- g. If our Bid is accepted, we commit to obtain a Performance Security in the amount of [insert percentage amount] percent of the Contract Price for the due performance of the Contract, or a Performance Securing Declaration in lieu of the the allowable forms of Performance Security, subject to the terms and conditions of issued GPPB guidelines<sup>2</sup> for this purpose;
- h. We are not participating, as Bidders, in more than one Bid in this bidding process, other than alternative offers in accordance with the Bidding Documents;
- i. We understand that this Bid, together with your written acceptance thereof included in your notification of award, shall constitute a binding contract between us, until a formal Contract is prepared and executed; and
- j. We understand that you are not bound to accept the Lowest Calculated Bid or any other Bid that you may receive.

k. We likewise certify/confirm that the undersigned, is the duly authorized representative of the bidder, and granted full power and authority to do, execute and perform any and all acts necessary to participate, submit the bid, and to sign and execute the ensuing contract for the [Name of Project] of the [Name of the Procuring Entity].

1. We acknowledge that failure to sign each and every page of this Bid Form, including the Bill of Quantities, shall be a ground for the rejection of our bid.

Name: \_\_\_\_\_ Legal  
Capacity: \_\_\_\_\_ Signature:  
\_\_\_\_\_ Duly authorized to  
sign the Bid for and behalf of: \_\_\_\_\_ Date:  
\_\_\_\_\_

# **Contract Agreement Form for the Procurement of Infrastructure Projects (Revised)**

[not required to be submitted with the Bid, but it shall be submitted  
within ten (10) days after receiving the Notice of Award]

---

## **CONTRACT AGREEMENT**

THIS AGREEMENT, made this [insert date] day of [insert month], [insert year] between [name and address of PROCURING ENTITY] (hereinafter called the “Entity”) and [name and address of Contractor] (hereinafter called the “Contractor”).

WHEREAS, the Entity is desirous that the Contractor execute [name and identification number of contract] (hereinafter called “the Works”) and the Entity has accepted the Bid for [contract price in words and figures in specified currency] by the Contractor for the execution and completion of such Works and the remedying of any defects therein.

NOW THIS AGREEMENT WITNESSETH AS FOLLOWS:

1. In this Agreement, words and expressions shall have the same meanings as are respectively assigned to them in the Conditions of Contract hereinafter referred to.
2. The following documents as required by the 2016 revised Implementing Rules and Regulations of Republic Act No. 9184 shall be deemed to form and be read and construed as part of this Agreement, viz.:

- a. Philippine Bidding Documents (PBDs);
  - i. Drawings/Plans;
  - ii. Specifications;
  - iii. Bill of Quantities;
  - iv. General and Special Conditions of Contract;
  - v. Supplemental or Bid Bulletins, if any;
- b. Winning bidder’s bid, including the Eligibility requirements, Technical and Financial Proposals, and all other documents or statements submitted;

Bid form, including all the documents/statements contained in the Bidder’s bidding envelopes, as annexes, and all other documents submitted (e.g., Bidder’s response to request for clarifications on the bid), including corrections to the bid, if any, resulting from the Procuring Entity’s bid evaluation;

- c. Performance Security;
- d. Notice of Award of Contract and the Bidder’s conforme thereto; and

Other contract documents that may be required by existing laws and/or the Procuring Entity concerned in the PBDs. Winning bidder agrees that additional contract documents or information



prescribed by the GPPB that are subsequently required for submission after the contract execution, such as the

- e. Notice to Proceed, Variation Orders, and Warranty Security, shall likewise form part of the Contract.
- 5. In consideration for the sum of [total contract price in words and figures] or such other sums as may be ascertained, [Named of the bidder] agrees to [state the object of the contract] in accordance with his/her/its Bid.
- 6. 4. The [Name of the procuring entity] agrees to pay the above-mentioned sum in accordance with the terms of the Bidding.

IN WITNESS whereof the parties thereto have caused this Agreement to be executed the day and year first before written.

[Insert Name and Signature]

[Insert Name and Signature]

[Insert Signatory's Legal Capacity]

[Insert Signatory's Legal Capacity]

for:

for:

[Insert Procuring Entity]

[Insert Procuring Entity]

#### Acknowledgment

[Format shall be based on the latest Rules on Notarial Practice]

**Statement of All On-Going Government and Private Contracts, Including Contracts Awarded but Not Yet Started, Whether Similar or Not Similar in Nature and Complexity to the Contract to be Bid**

---

Business Name:

Business Address:

**A. Government**

Nature of Contract (Project Title)	a. Owner's Name	Project Cost	Bidder's Role		a. Date Awarded	% of Accomplishment		Value of Outstanding Works (Undelivered Portion)
	b. Address		Description	%	b. Date Started	Planned	Actual	
	c. Contact Nos.				c. Target Date of Completion			
1.	a.				a.			
	b.				b.			
	c.				c.			
2.	a.				a.			
	b.				b.			
	c.				c.			

**B. Private**

Nature of Contract (Project Title)	a. Owner's Name	Project Cost	Bidder's Role		a. Date Awarded	% of Accomplishment		Value of Outstanding Works (Undelivered Portion)
	b. Address		Description	%	b. Date Started	Planned	Actual	
	c. Contact Nos.				c. Target Date of Completion			
1.	a.				a.			

	b.				b.			
	c.				c.			
2.	a.				a.			
	b.				b.			
	c.				c.			

Note: The following documents must be attached to support this statement: and its original copy of documents must be available upon request of the Bids and Award Committee (BAC) or designated Technical Working Group (TWG) during Post-Qualification:

(a) **Notice of Award**, (b) **Contract or Purchase Order** (c) **Notice to Proceed** as may be applicable.

Name: \_\_\_\_\_

Legal Capacity: \_\_\_\_\_

Signature: \_\_\_\_\_

Duly authorized to sign the Bid for and behalf of: \_\_\_\_\_

**Statement of Single Largest Completed Contract (SLCC)  
Similar to the Contract to be Bid**

---

Business Name: \_\_\_\_\_

Business Address: \_\_\_\_\_

Nature of Contract (Project Title)	a. Owner's Name	Project Cost	Bidder's Role		a. Date Awarded
	b. Address				b. Date Started
	c. Contact Nos.		Description	%	c. Date Completed
	a.				a.
	b.				b.
	c.				c.

Note: The following documents must be attached to support this statement and its original copy of documents must be available upon request of the Bids and Award Committee (BAC) or designated Technical Working Group (TWG) during Post-Qualification:

- (a) Official Receipt(s) or Sales Invoice;
- (b) User's Certificate of Completion with at least Satisfactory Rating or any duly issued certificate showing a minimum satisfactory performance of the bidder.
- (c) Certificate of Final Acceptance

Name: \_\_\_\_\_

Legal Capacity: \_\_\_\_\_

Signature: \_\_\_\_\_

Duly authorized to sign the Bid for and behalf of \_\_\_\_\_

*The Bidder must have completed, within the period specified in the Invitation to Bid and ITB Clause 12.1(a)(ii), a single contract that is similar to the project to be bid, equivalent to a percentage (%) of the ABC specified in ITB Clause 5.4.*

